

Assembly description for C32442.001 & C32442.002 & C32442.003

| | | | | |
|----------------------------|---------------------------------|---------------|-------------------------|-----------------|
| Prepared by Marek Kasar | Date (dd.mm.yyyy) 09.12.2008 | Revision 1 | Document no. 2056580 | Page 1 of 23 |
|----------------------------|---------------------------------|---------------|-------------------------|-----------------|

General Assembly description

Applicable Part

| Eltek Valere part no. | IFS part name | Part type | Revision |
|-----------------------|--------------------------------------|------------|----------|
| <i>C32442.001</i> | <i>FP2 72kW 48V 3x400V 2xTPS2 G1</i> | <i>FP2</i> | <i>3</i> |
| <i>C32442.002</i> | <i>FP2 72kW 48V 3x400V 2xTPS2 G1</i> | <i>FP2</i> | <i>3</i> |
| <i>C32442.003</i> | <i>FP2 72kW 48V 3x400V 2xTPS2 G1</i> | <i>FP2</i> | <i>3</i> |

Front view with panels



Label:
Master system

Label:
Slave system
No. 1, 2 and 3

Assembly description for C32442.001 & C32442.002 & C32442.003

| | | | | |
|----------------------------|---------------------------------|---------------|-------------------------|-----------------|
| Prepared by Marek Kasar | Date (dd.mm.yyyy) 09.12.2008 | Revision 1 | Document no. 2056580 | Page 2 of 23 |
|----------------------------|---------------------------------|---------------|-------------------------|-----------------|

Back view with panels

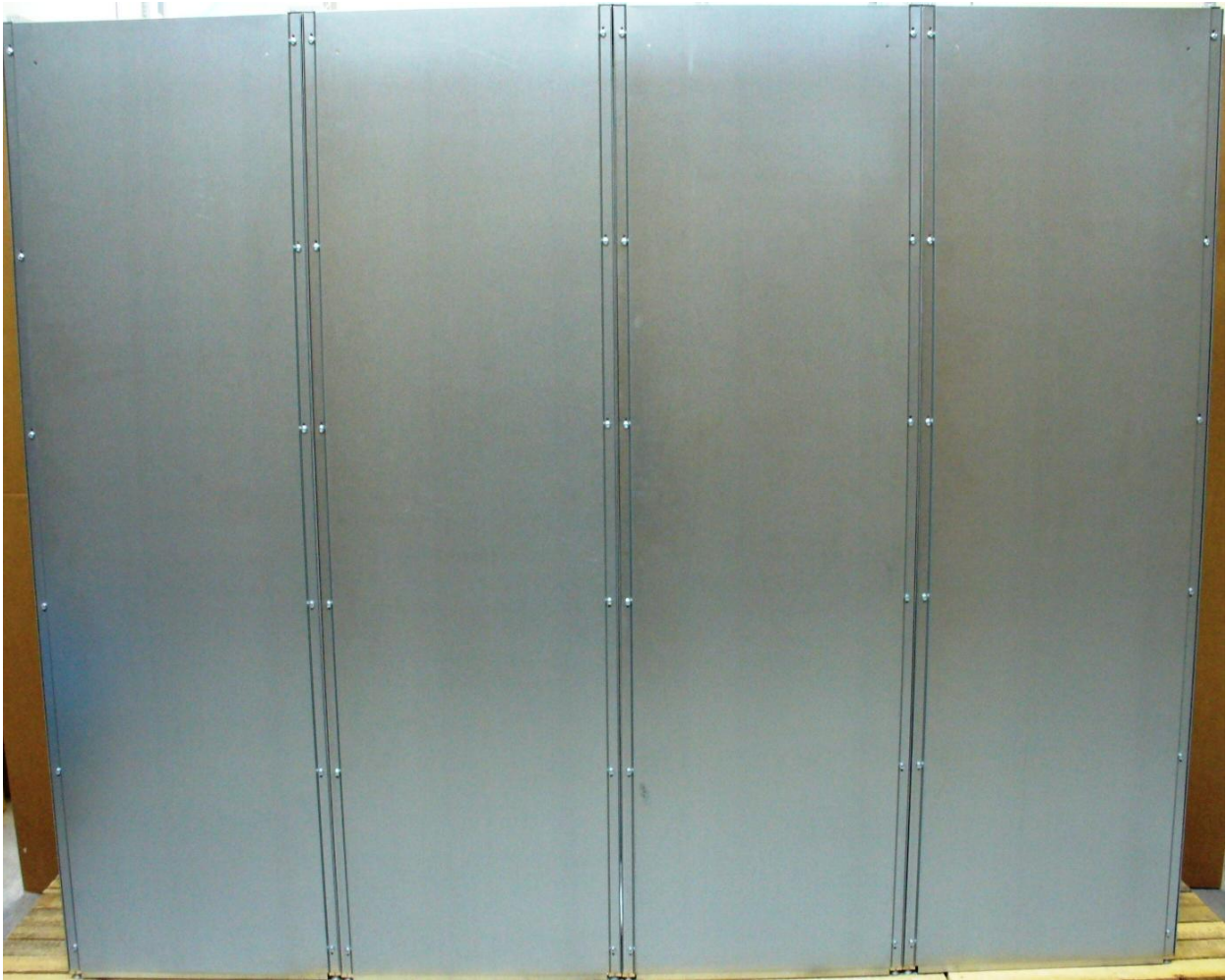

Assembly description for C32442.001 & C32442.002 & C32442.003

Prepared by
Marek Kasar

Date (dd.mm.yyyy)
09.12.2008

Revision
1

Document no.
2056580

Page
3 of 23

Front view without panels

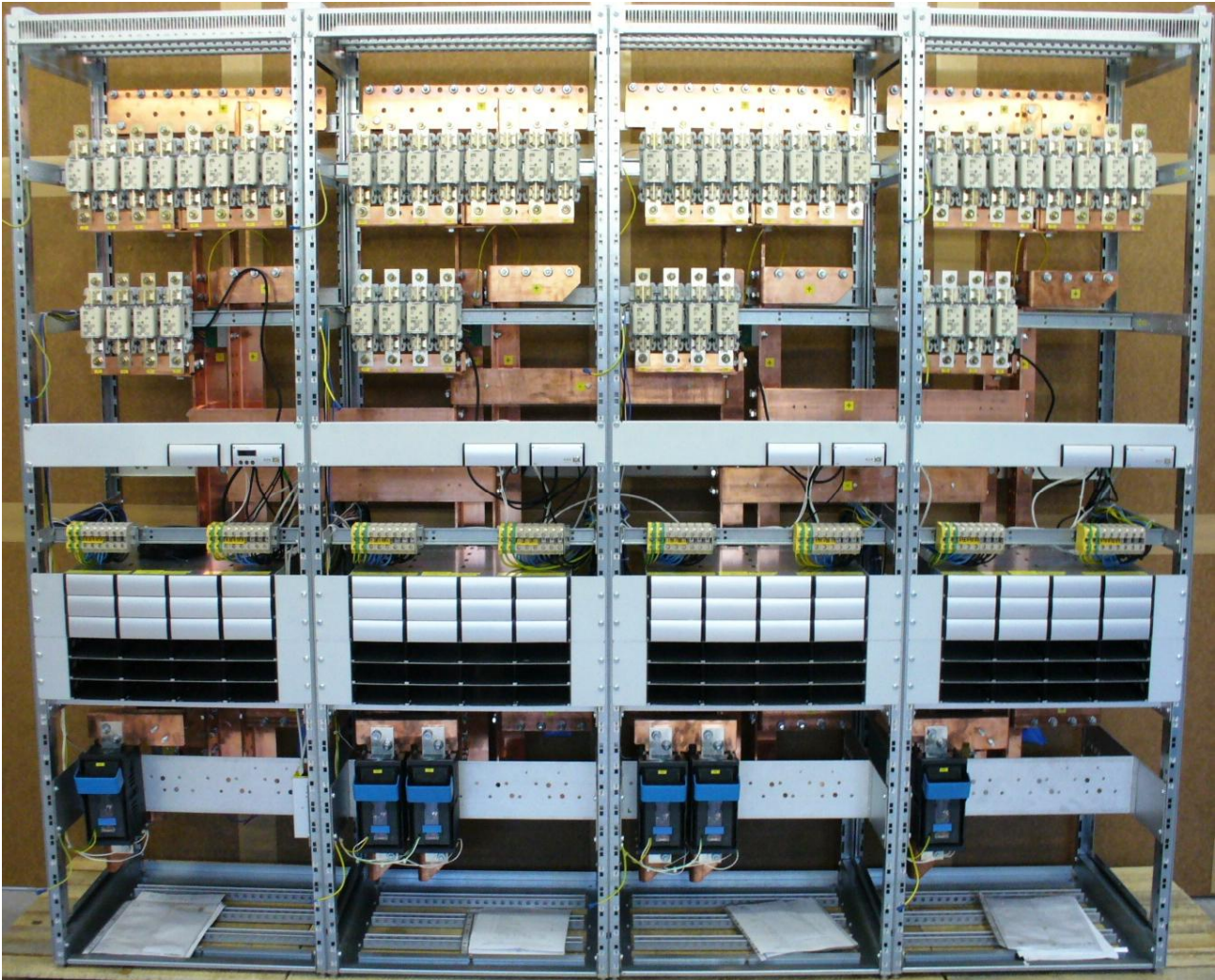

Assembly description for C32442.001 & C32442.002 & C32442.003

Prepared by
Marek Kasar

Date (dd.mm.yyyy)
09.12.2008

Revision
1

Document no.
2056580

Page
4 of 23

Back view without panels

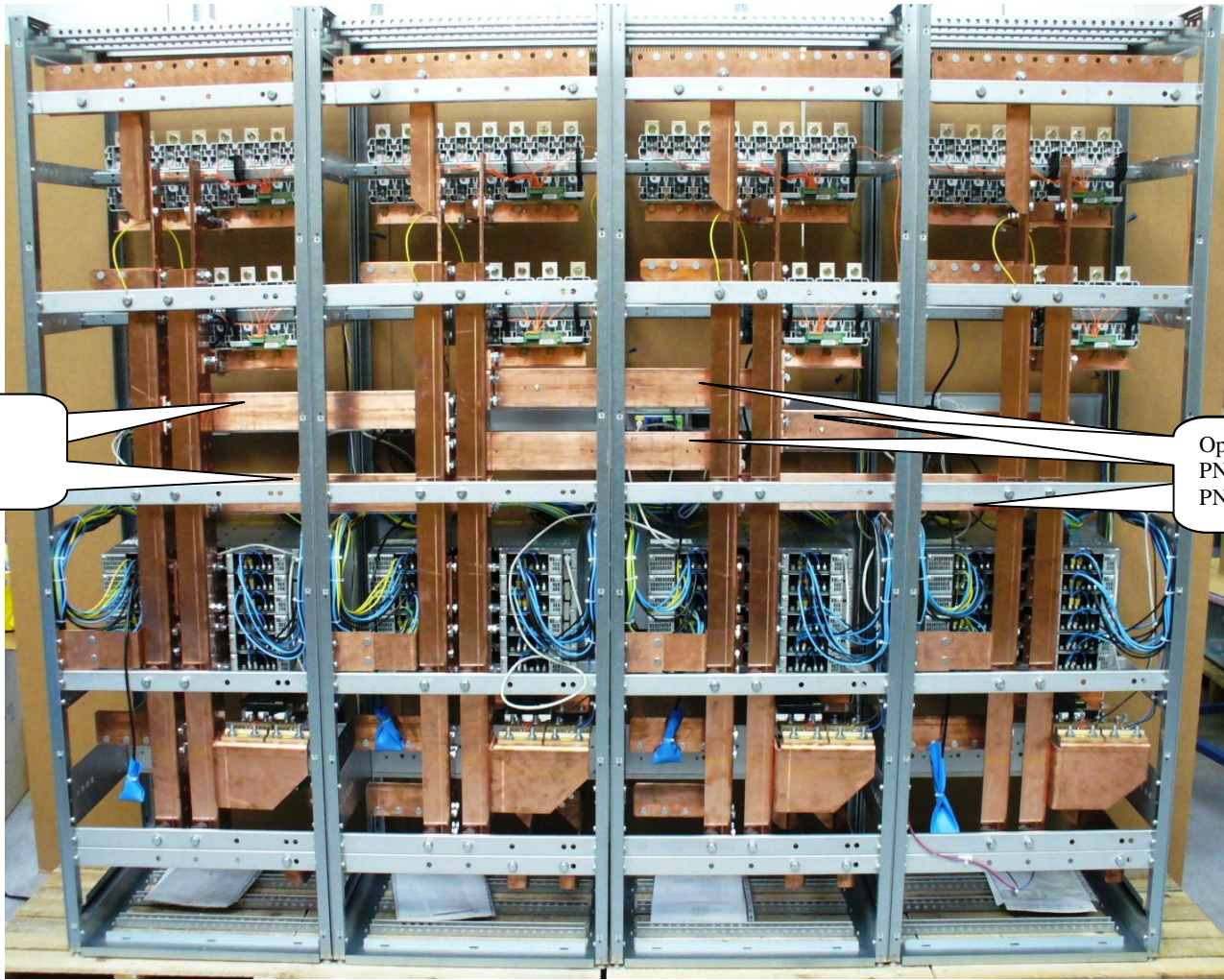



Optional kit
PN 219052
PN 219053

Optional kit
PN 219052
PN 219053

| | | | | |
|----------------------------|---------------------------------|---------------|-------------------------|-----------------|
| Prepared by Marek Kasar | Date (dd.mm.yyyy) 09.12.2008 | Revision 1 | Document no. 2056580 | Page 5 of 23 |
|----------------------------|---------------------------------|---------------|-------------------------|-----------------|

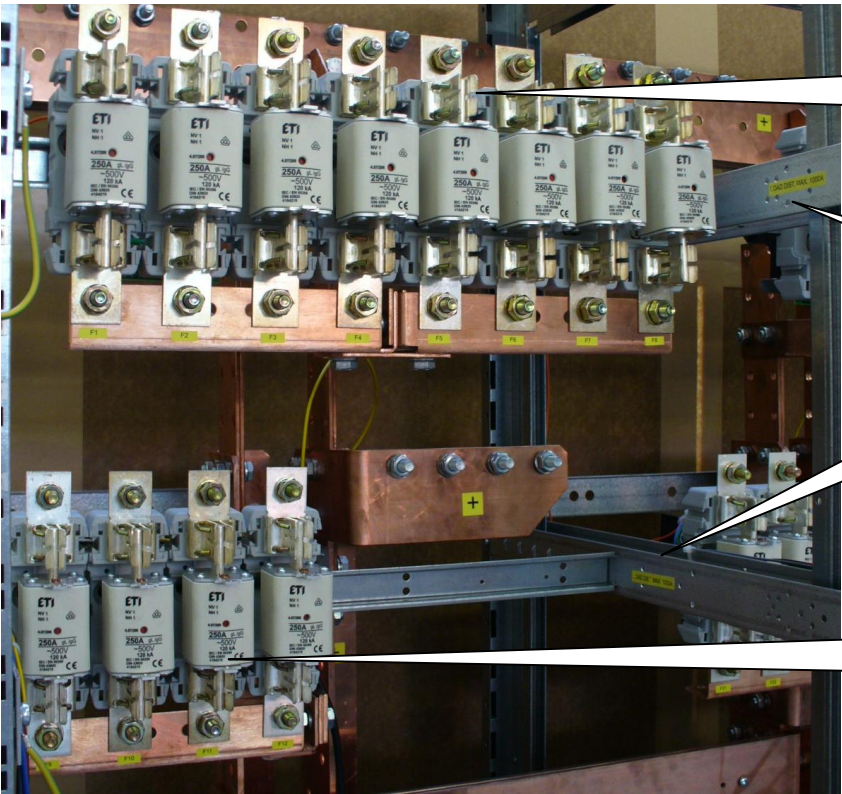
Assembly details for C32442.001 (Master system)

| Picture | Comment |
|--|---|
|  | <p>Load Distribution 1 - Fuses 8x 250A NH1 (F1 – F8)</p> |
| | <p>Label <i>Load dist. max. 1000A</i></p> |
| | <p>Load Distribution 2 Fuses 4x 250A – NH1 (F9 – F12)</p> |

| Picture | Comment |
|--|---|
|  | <p>Alarm board</p> |
| | <p>Smartpack – Monitoring/Control unit 242100.110</p> |

Assembly description for C32442.001 & C32442.002 & C32442.003

| | | | | |
|----------------------------|---------------------------------|---------------|-------------------------|-----------------|
| Prepared by Marek Kasar | Date (dd.mm.yyyy) 09.12.2008 | Revision 1 | Document no. 2056580 | Page 6 of 23 |
|----------------------------|---------------------------------|---------------|-------------------------|-----------------|

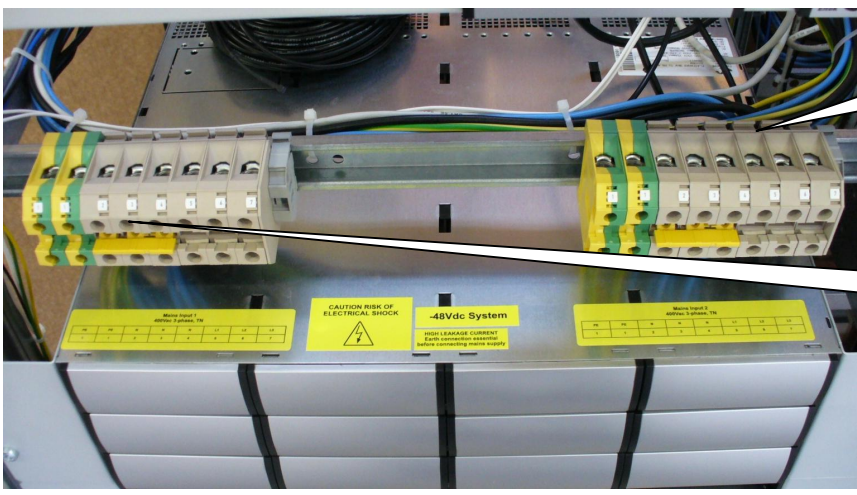
| Picture | Comment |
|--|---|
|  | <p data-bbox="1069 369 1428 470">Mains input 2 400Vac 3-phase, TN</p> <p data-bbox="1069 616 1428 716">Mains input 1 400Vac 3-phase, TN</p> |

| Picture | Comment |
|---|---|
|  | <p data-bbox="1101 1052 1340 1131">Mains input 2</p> <p data-bbox="1101 1288 1340 1366">Mains input 1</p> |

Assembly description for C32442.001 & C32442.002 & C32442.003

| | | | | |
|----------------------------|---------------------------------|---------------|-------------------------|-----------------|
| Prepared by Marek Kasar | Date (dd.mm.yyyy) 09.12.2008 | Revision 1 | Document no. 2056580 | Page 7 of 23 |
|----------------------------|---------------------------------|---------------|-------------------------|-----------------|

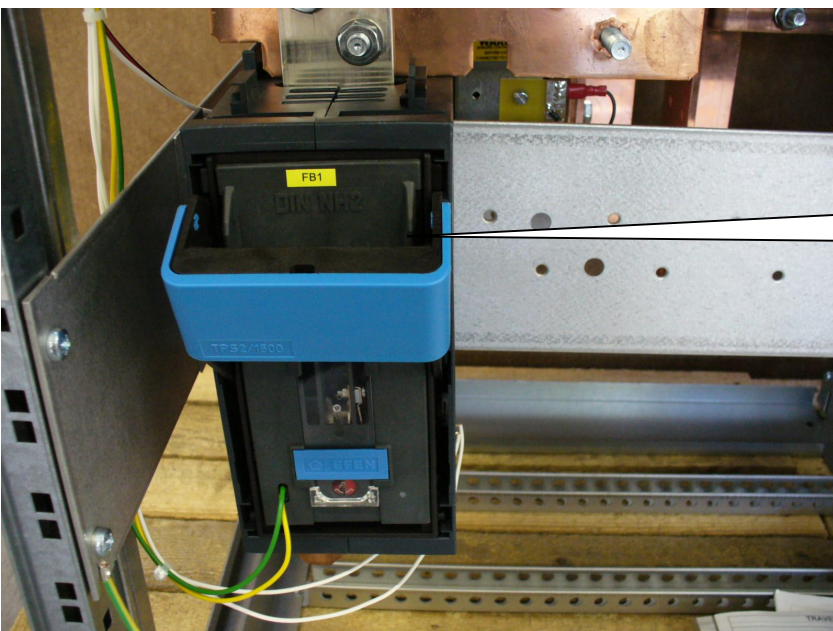
| Picture | Comment |
|---|---|
|  | <p data-bbox="1101 504 1396 638">Battery fuse 1x TPS2 1600A (FB1)</p> |

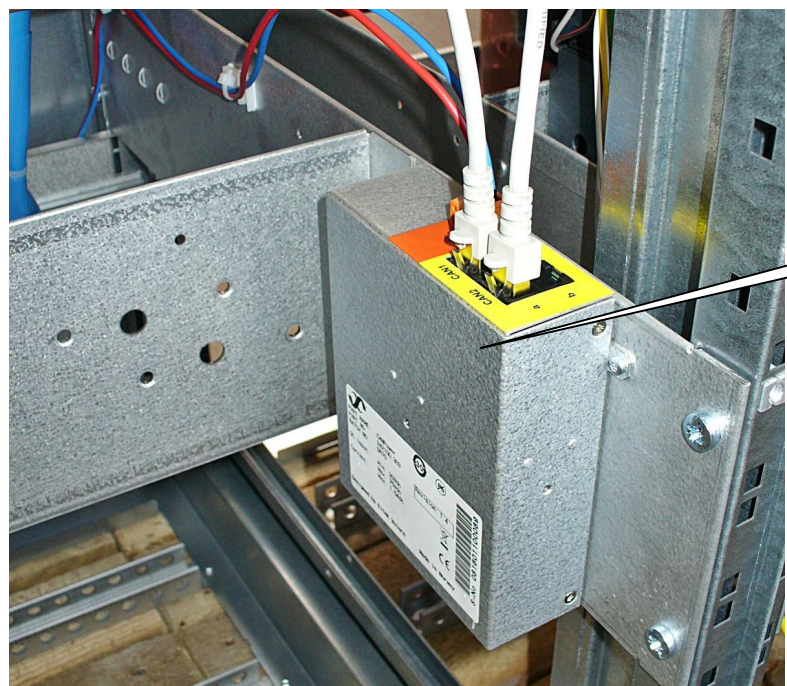
| Picture | Comment |
|---|--|
|  | <p data-bbox="1069 1288 1364 1355">CAN power</p> |

Assembly description for C32442.001 & C32442.002 & C32442.003

| | | | | |
|----------------------------|---------------------------------|---------------|-------------------------|-----------------|
| Prepared by Marek Kasar | Date (dd.mm.yyyy) 09.12.2008 | Revision 1 | Document no. 2056580 | Page 8 of 23 |
|----------------------------|---------------------------------|---------------|-------------------------|-----------------|

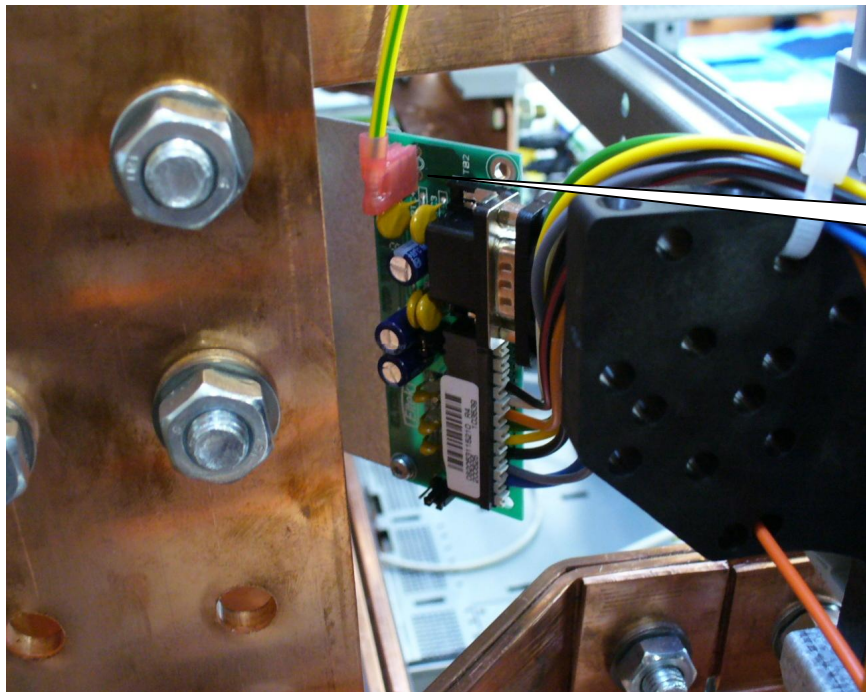
| Picture | Comment |
|---|--|
|  | <p data-bbox="1086 517 1377 613">System connection board</p> |

| Picture | Comment |
|--|--|
|  | <p data-bbox="1129 1220 1417 1294">1x 1800A LVBD</p> <p data-bbox="1114 1534 1433 1630">2x shunt 1000A (SH1,SH2)</p> |

Assembly description for C32442.001 & C32442.002 & C32442.003

| | | | | |
|----------------------------|---------------------------------|---------------|-------------------------|-----------------|
| Prepared by Marek Kasar | Date (dd.mm.yyyy) 09.12.2008 | Revision 1 | Document no. 2056580 | Page 9 of 23 |
|----------------------------|---------------------------------|---------------|-------------------------|-----------------|

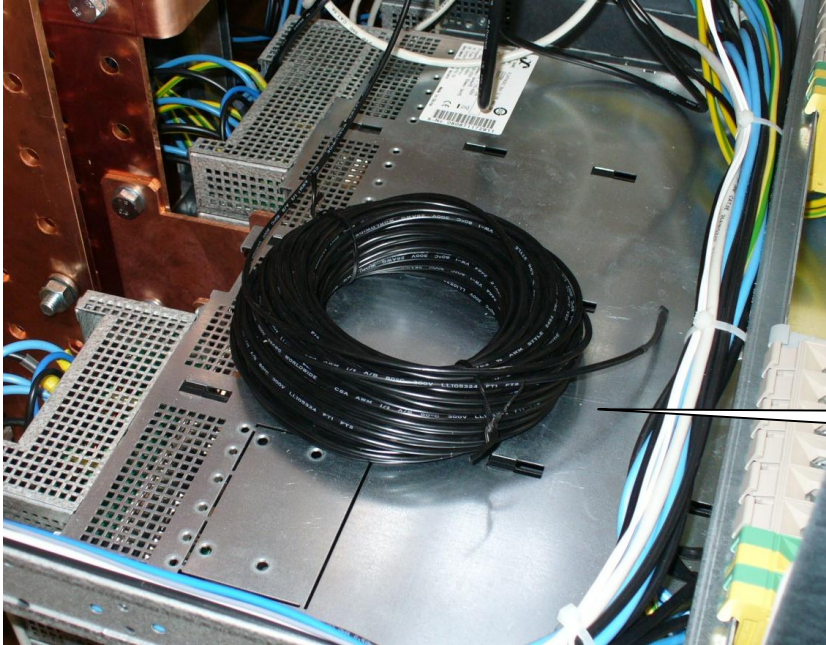
| Picture | Comment |
|---|--------------------------|
|  | <p>Temp.sensor (30m)</p> |

| Picture | Comment |
|---|---|
|  | <p>Enclosed documents and parts.</p> |

| | | | | |
|----------------------------|---------------------------------|---------------|-------------------------|------------------|
| Prepared by Marek Kasar | Date (dd.mm.yyyy) 09.12.2008 | Revision 1 | Document no. 2056580 | Page 10 of 23 |
|----------------------------|---------------------------------|---------------|-------------------------|------------------|

Assembly details for C32442.002 (Slave system 1)

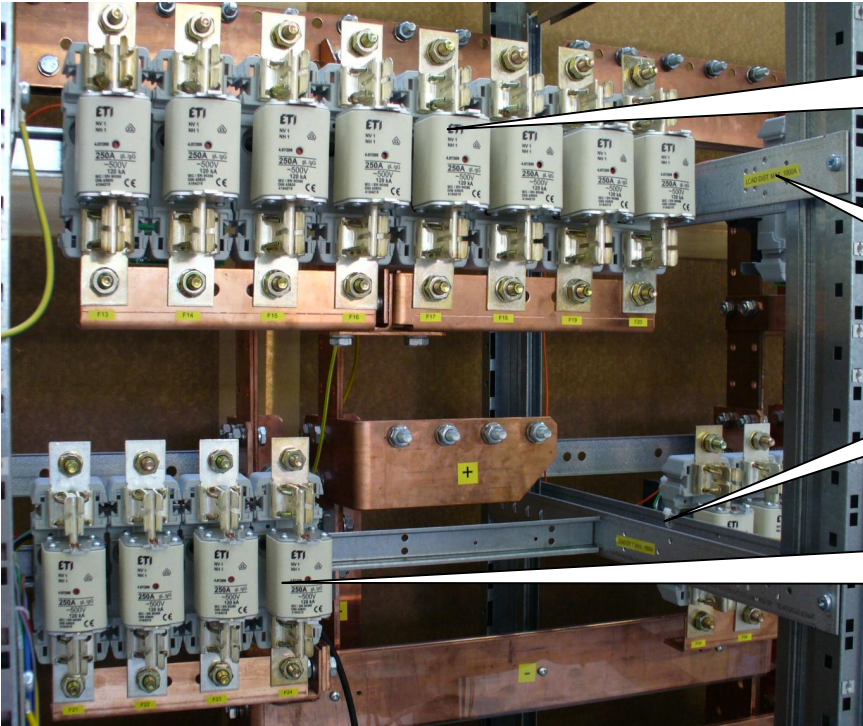
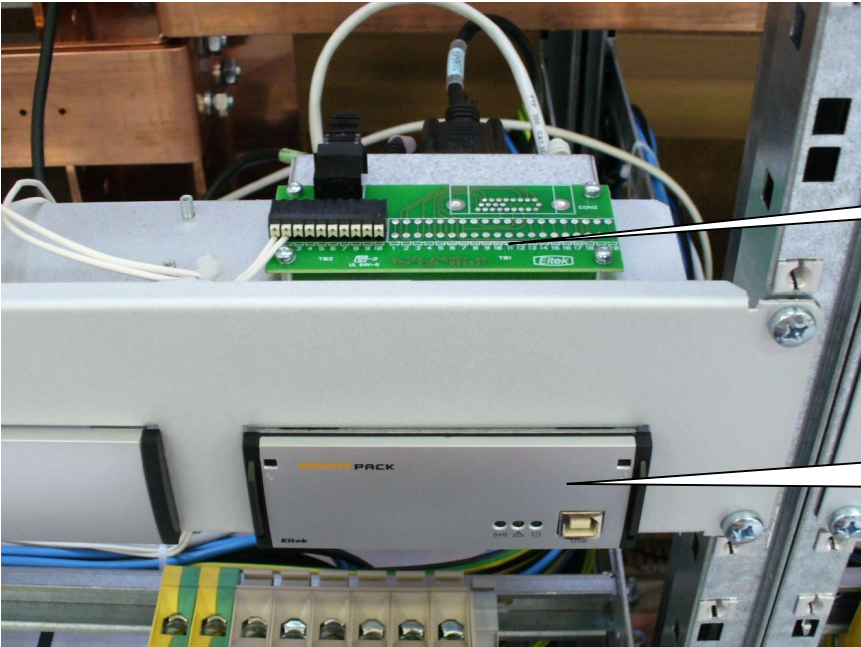
| Picture | Comment |
|--|--|
|  | <p>Load Distribution 3 - Fuses 8x 250A – NH1 (F13 – F20)</p> <p>Label: <i>Load dist. max. 1000A</i></p> <p>Load Distribution 4 Fuses 4x 250A – NH1 (F21 – F24)</p> |
|  | <p>Alarm board</p> <p>Smartpack 242100.000 – Monitoring Control unit</p> |

Assembly description for C32442.001 & C32442.002 & C32442.003

| | | | | |
|----------------------------|---------------------------------|---------------|-------------------------|------------------|
| Prepared by Marek Kasar | Date (dd.mm.yyyy) 09.12.2008 | Revision 1 | Document no. 2056580 | Page 11 of 23 |
|----------------------------|---------------------------------|---------------|-------------------------|------------------|

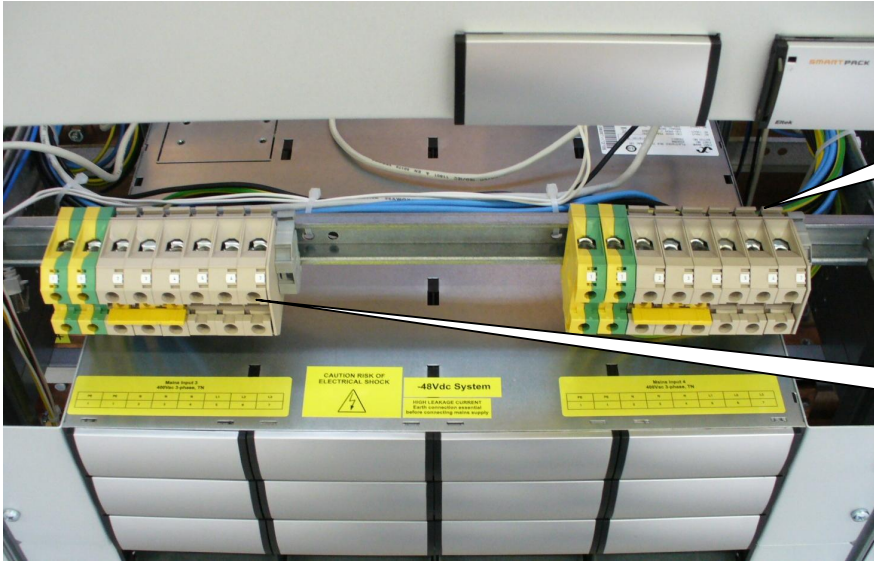
| Picture | Comment |
|--|---|
|  | <p data-bbox="1086 416 1430 510">Mains input 4 400Vac 3-phase, TN</p> <p data-bbox="1086 689 1430 784">Mains input 3 400Vac 3-phase, TN</p> |

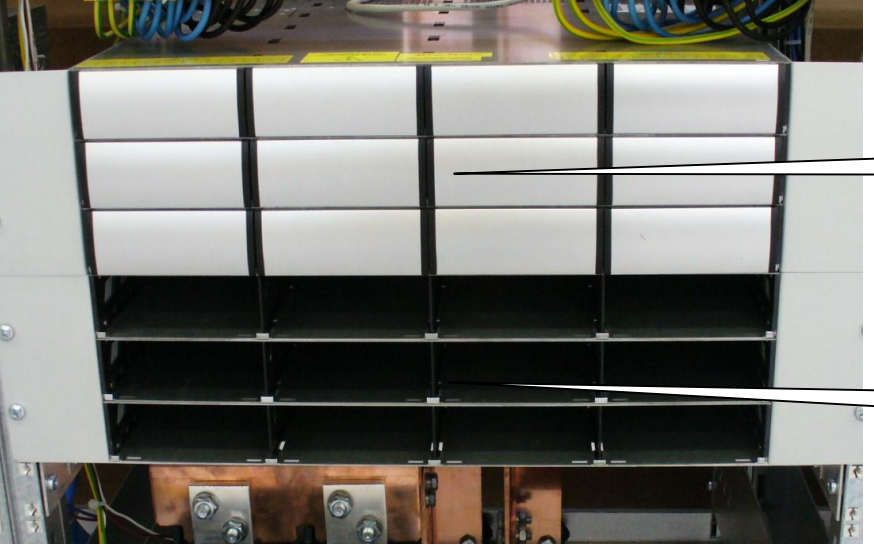
| Picture | Comment |
|--|---|
|  | <p data-bbox="1086 1451 1430 1523">Mains input 4</p> <p data-bbox="1086 1720 1430 1792">Mains input 3</p> |

Assembly description for C32442.001 & C32442.002 & C32442.003

| | | | | |
|----------------------------|---------------------------------|---------------|-------------------------|------------------|
| Prepared by Marek Kasar | Date (dd.mm.yyyy) 09.12.2008 | Revision 1 | Document no. 2056580 | Page 12 of 23 |
|----------------------------|---------------------------------|---------------|-------------------------|------------------|

| Picture | Comment |
|--|--|
|  | <p data-bbox="1134 595 1422 734">Battery fuse 2x TPS2 1600A (FB2, FB3)</p> |

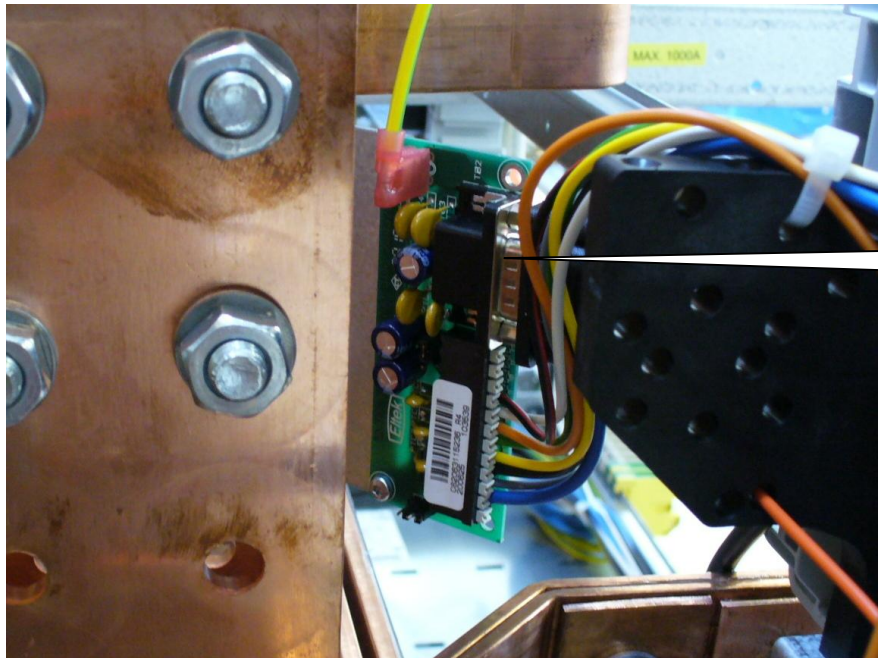
| Picture | Comment |
|--|--|
|  | <p data-bbox="1118 1357 1410 1451">System connection board</p> |

Assembly description for C32442.001 & C32442.002 & C32442.003

| | | | | |
|----------------------------|---------------------------------|---------------|-------------------------|------------------|
| Prepared by Marek Kasar | Date (dd.mm.yyyy) 09.12.2008 | Revision 1 | Document no. 2056580 | Page 13 of 23 |
|----------------------------|---------------------------------|---------------|-------------------------|------------------|

| Picture | Comment |
|--|--|
|  | <p>1x 1800A LVBD</p> <p>2x shunt 1000A (SH1,SH2)</p> |

| Picture | Comment |
|---|--------------------------------------|
|  | <p>Enclosed documents and parts.</p> |

Assembly description for C32442.001 & C32442.002 & C32442.003

| | | | | |
|----------------------------|---------------------------------|---------------|-------------------------|------------------|
| Prepared by Marek Kasar | Date (dd.mm.yyyy) 09.12.2008 | Revision 1 | Document no. 2056580 | Page 14 of 23 |
|----------------------------|---------------------------------|---------------|-------------------------|------------------|

Assembly details for C32442.002 (Slave system 2)

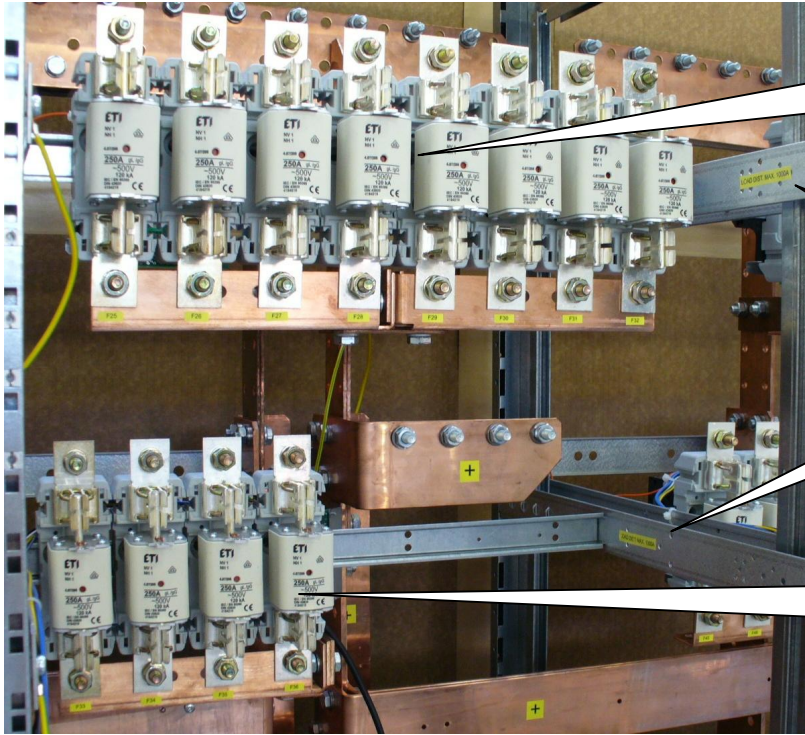
| Picture | Comment |
|--|---|
|  | <p data-bbox="1059 465 1430 600">Load Distribution 5 - Fuses 8x 250A – NH1 (F25 – F32)</p> <p data-bbox="1059 748 1407 869">Label: <i>Load dist. max. 1000A</i></p> <p data-bbox="1086 1039 1430 1173">Load Distribution 6 Fuses 4x 250A – NH1 (F33 – F36),</p> |

| Picture | Comment |
|--|--|
|  | <p data-bbox="1145 1503 1385 1574">Alarm board</p> <p data-bbox="1075 1794 1422 1906">Smartpack 242100.000 – Monitoring Control unit</p> |

Assembly description for C32442.001 & C32442.002 & C32442.003

| | | | | |
|----------------------------|---------------------------------|---------------|-------------------------|------------------|
| Prepared by Marek Kasar | Date (dd.mm.yyyy) 09.12.2008 | Revision 1 | Document no. 2056580 | Page 15 of 23 |
|----------------------------|---------------------------------|---------------|-------------------------|------------------|

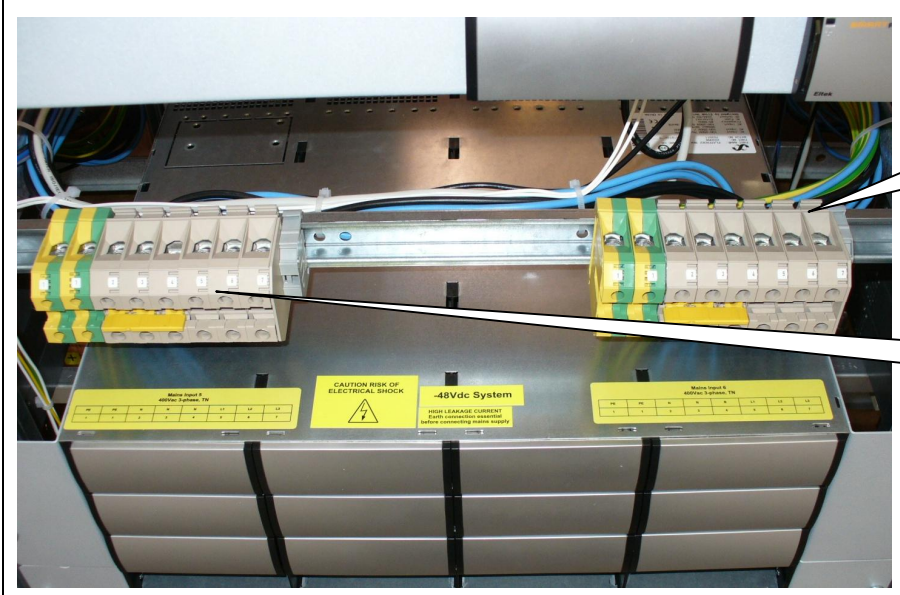
| Picture | Comment |
|--|---|
|  | <p data-bbox="1070 416 1417 510">Mains input 6 400Vac 3-phase, TN</p> <p data-bbox="1070 640 1417 734">Mains input 5 400Vac 3-phase, TN</p> |

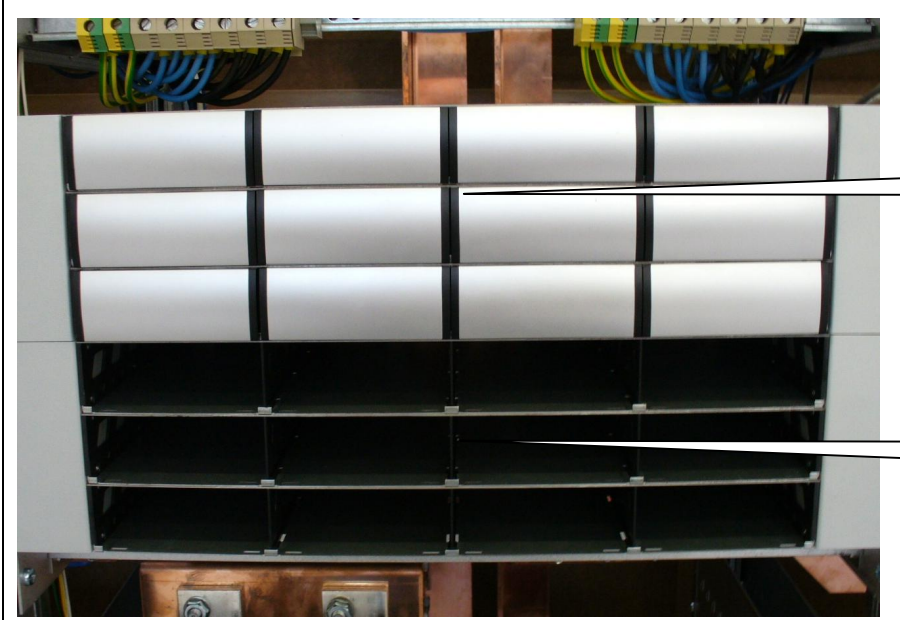
| Picture | Comment |
|--|---|
|  | <p data-bbox="1070 1256 1417 1328">Mains input 6</p> <p data-bbox="1070 1525 1417 1597">Mains input 5</p> |

Assembly description for C32442.001 & C32442.002 & C32442.003

| | | | | |
|----------------------------|---------------------------------|---------------|-------------------------|------------------|
| Prepared by Marek Kasar | Date (dd.mm.yyyy) 09.12.2008 | Revision 1 | Document no. 2056580 | Page 16 of 23 |
|----------------------------|---------------------------------|---------------|-------------------------|------------------|

| Picture | Comment |
|---|--|
|  | <p data-bbox="1145 607 1410 734">Battery fuse 2x TPS2 1600A (FB4, FB5)</p> |

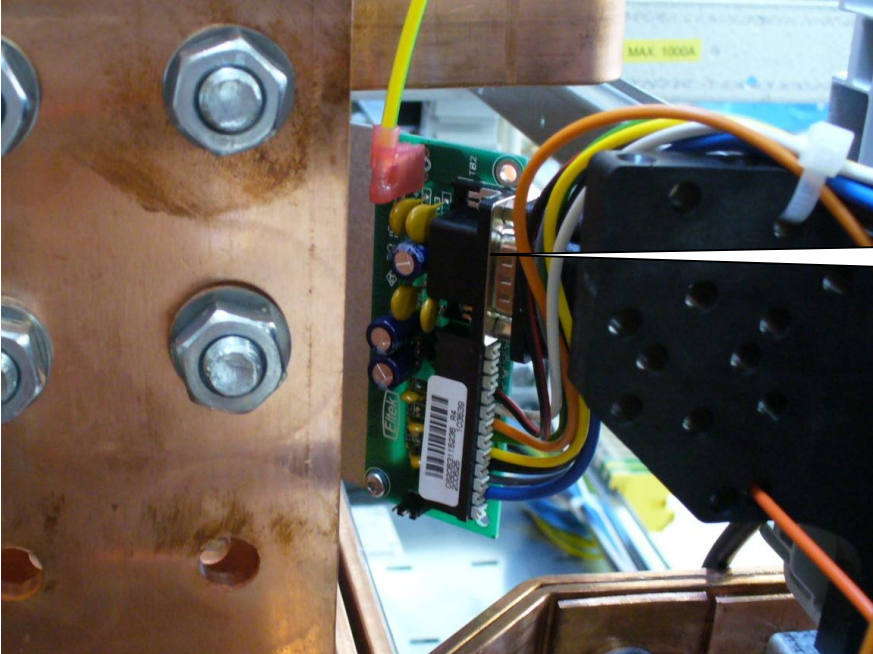
| Picture | Comment |
|--|--|
|  | <p data-bbox="1134 1397 1399 1480">System connection board</p> |

Assembly description for C32442.001 & C32442.002 & C32442.003

| | | | | |
|----------------------------|---------------------------------|---------------|-------------------------|------------------|
| Prepared by Marek Kasar | Date (dd.mm.yyyy) 09.12.2008 | Revision 1 | Document no. 2056580 | Page 17 of 23 |
|----------------------------|---------------------------------|---------------|-------------------------|------------------|

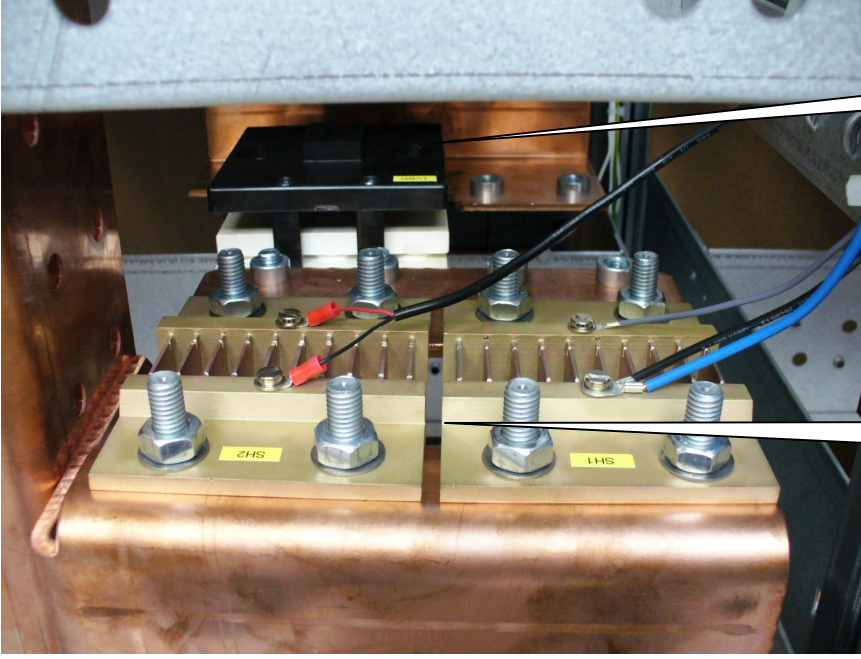
| Picture | Comment |
|--|--|
|  | <p>1x 1800A LVBD</p> <p>2x shunt 1000A (SH1,SH2)</p> |

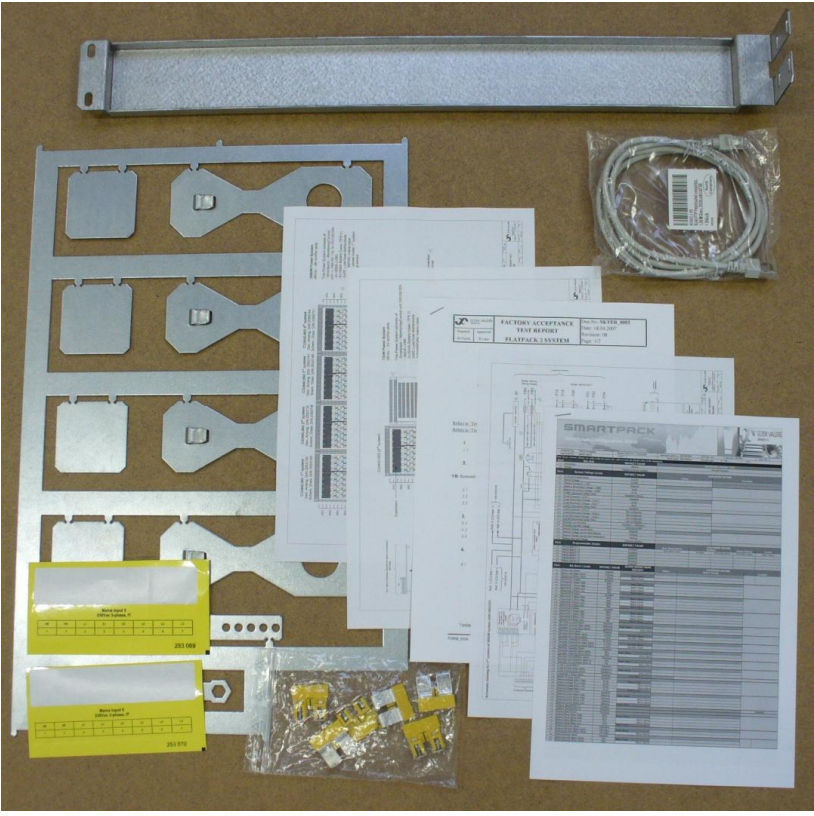
| Picture | Comment |
|---|--------------------------------------|
|  | <p>Enclosed documents and parts.</p> |

Assembly description for C32442.001 & C32442.002 & C32442.003

| | | | | |
|----------------------------|---------------------------------|---------------|-------------------------|------------------|
| Prepared by Marek Kasar | Date (dd.mm.yyyy) 09.12.2008 | Revision 1 | Document no. 2056580 | Page 18 of 23 |
|----------------------------|---------------------------------|---------------|-------------------------|------------------|

Assembly details for C32442.002 (Slave system 3)

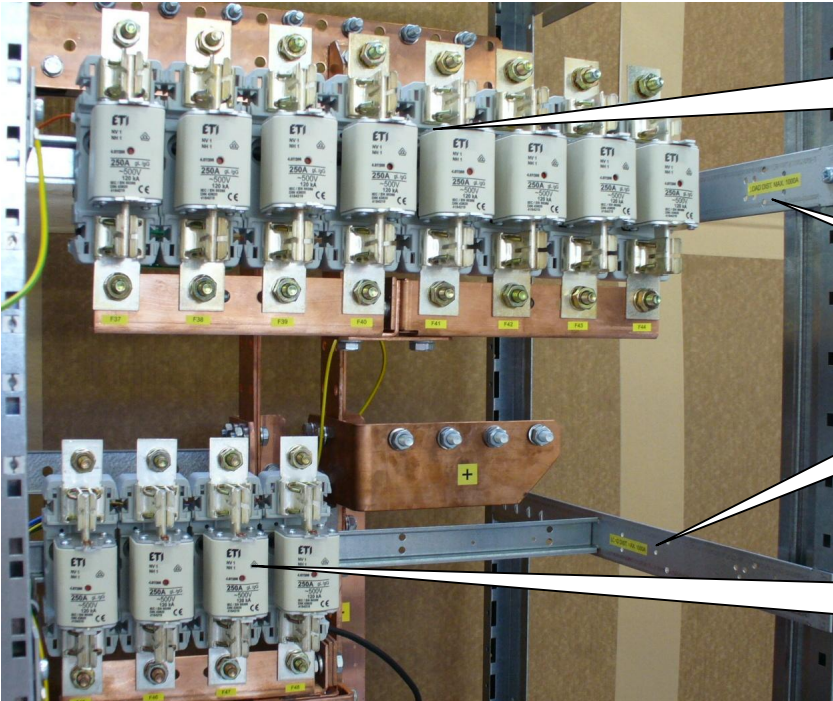
| Picture | Comment |
|---|---|
|  | <p data-bbox="1059 465 1430 600">Load Distribution 7 - Fuses 8x 250A – NH1 (F37 – F44)</p> <p data-bbox="1059 748 1407 860">Label: <i>Load dist. max. 1000A</i></p> <p data-bbox="1059 1034 1430 1169">Load Distribution 8 Fuses 4x 250A – NH1 (F45 – F48),</p> |

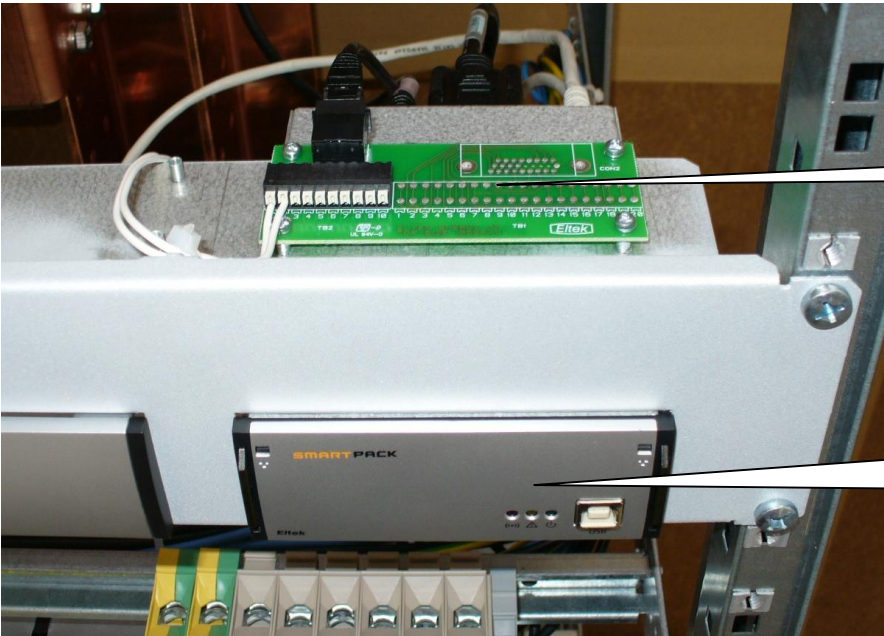
| Picture | Comment |
|--|--|
|  | <p data-bbox="1145 1469 1385 1541">Alarm board</p> <p data-bbox="1059 1760 1398 1872">Smartpack 242100.000 – Monitoring Control unit</p> |

Assembly description for C32442.001 & C32442.002 & C32442.003

| | | | | |
|----------------------------|---------------------------------|---------------|-------------------------|------------------|
| Prepared by Marek Kasar | Date (dd.mm.yyyy) 09.12.2008 | Revision 1 | Document no. 2056580 | Page 19 of 23 |
|----------------------------|---------------------------------|---------------|-------------------------|------------------|

| Picture | Comment |
|--|---|
|  | <p>Mains input 8 400Vac 3-phase, TN</p> <p>Mains input 7 400Vac 3-phase, TN</p> |

| Picture | Comment |
|--|---|
|  | <p>Mains input 8</p> <p>Mains input 7</p> |

Assembly description for C32442.001 & C32442.002 & C32442.003

| | | | | |
|----------------------------|---------------------------------|---------------|-------------------------|------------------|
| Prepared by Marek Kasar | Date (dd.mm.yyyy) 09.12.2008 | Revision 1 | Document no. 2056580 | Page 20 of 23 |
|----------------------------|---------------------------------|---------------|-------------------------|------------------|

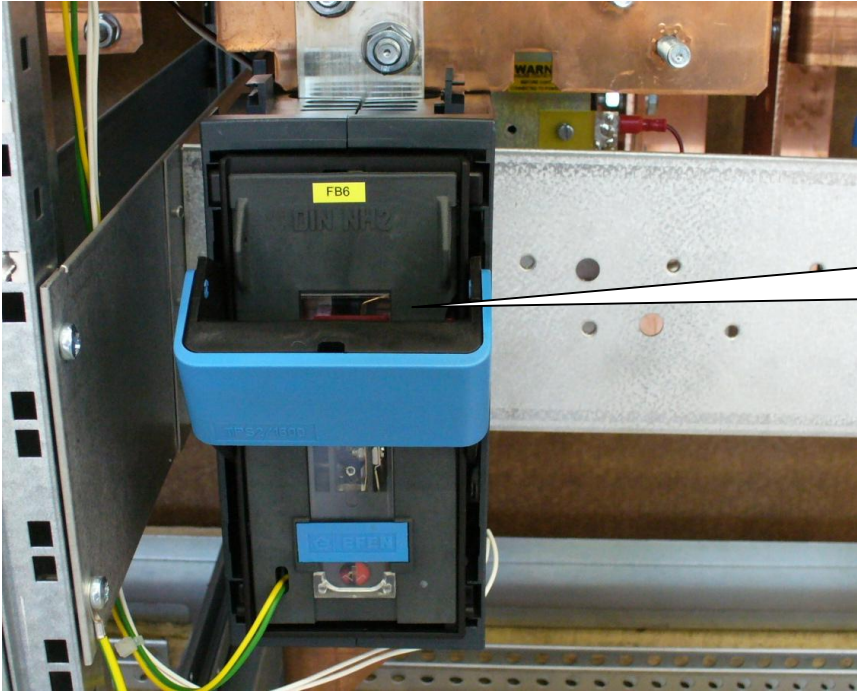
| Picture | Comment |
|---|---|
|  | <p>Battery fuse 1x TPS2 1600A (FB6)</p> |

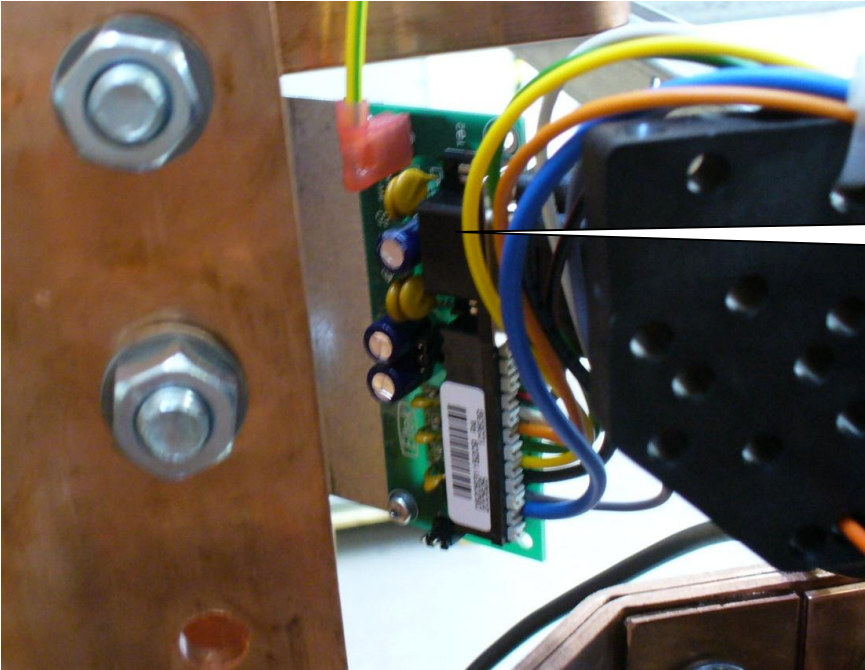
| Picture | Comment |
|--|------------------------------------|
|  | <p>System connection board</p> |

Assembly description for C32442.001 & C32442.002 & C32442.003

| | | | | |
|----------------------------|---------------------------------|---------------|-------------------------|------------------|
| Prepared by Marek Kasar | Date (dd.mm.yyyy) 09.12.2008 | Revision 1 | Document no. 2056580 | Page 21 of 23 |
|----------------------------|---------------------------------|---------------|-------------------------|------------------|

| Picture | Comment |
|--|--|
|  | <p>1x 1800A LVBD</p> <p>2x shunt 1000A (SH1,SH2)</p> |

| Picture | Comment |
|---|--------------------------------------|
|  | <p>Enclosed documents and parts.</p> |

Assembly description for C32442.001 & C32442.002 & C32442.003

| | | | | |
|----------------------------|---------------------------------|---------------|-------------------------|------------------|
| Prepared by Marek Kasar | Date (dd.mm.yyyy) 09.12.2008 | Revision 1 | Document no. 2056580 | Page 22 of 23 |
|----------------------------|---------------------------------|---------------|-------------------------|------------------|

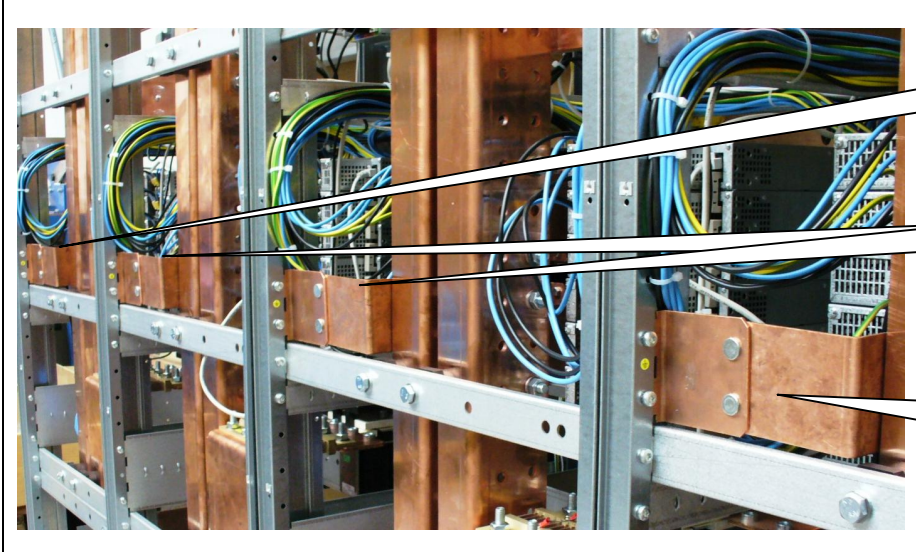
| Picture | Comment |
|--|---|
|  | <p>DC grounding positive for C32442.003</p> <p>DC grounding positive for C32442.002</p> <p>DC grounding positive for C32442.001</p> |

| Picture | Comment |
|--|---|
|  | <p>Special brackets for customer cable support</p> <p>PN 252923 C32442.001 enclosed, not mounted</p> <p>PN 252918 C32442.002 & C32442.003 enclosed, not mounted</p> |

Assembly description for C32442.001 & C32442.002 & C32442.003

| | | | | |
|----------------------------|---------------------------------|---------------|-------------------------|------------------|
| Prepared by Marek Kasar | Date (dd.mm.yyyy) 09.12.2008 | Revision 1 | Document no. 2056580 | Page 23 of 23 |
|----------------------------|---------------------------------|---------------|-------------------------|------------------|

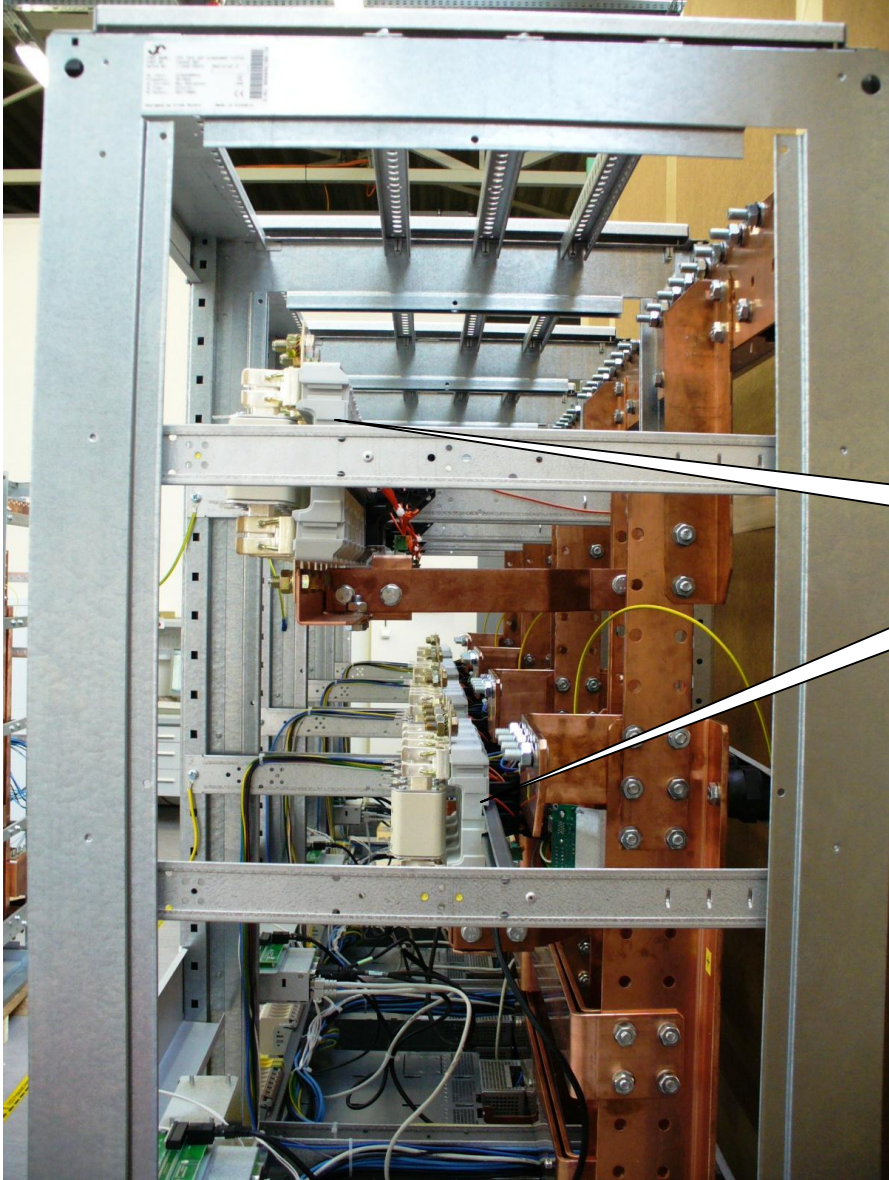
| Picture | Comment |
|--|--|
|  <p>The image shows a side view of a complex metal assembly. It features a main frame of silver-colored metal rails. Inside, there are several horizontal copper busbars connected by vertical copper bars. Various electrical components, including connectors and cables, are visible. A callout box points to a specific area of the assembly.</p> | <p>Detailed side view on load distribution</p> |