

AC Rack

ACR INV222-6.75 HV

USER MANUAL



Notes to this manual

ATTENTION! Read this manual very carefully before installing and commissioning the AC rack. This manual is a part of the delivered AC rack. Familiarity with the contents of this manual is required for installing and operating the AC rack. The rules for prevention of accidents for the specific country and the general safety rules in accordance with IEC 364 must be observed.

The function description in this manual corresponds to the date of publishing. Technical changes and changes in form and content can be made at any time by the manufacturer without notice. There are no obligations to update the manual continually.

The AC rack is manufactured in accordance with applicable DIN and VDE standards such as VDE 0106 (part 100) and VDE 0100 (part 410). The CE marking on the module confirms compliance with EU standards 2006-95-EG (low voltage) and 89/339 EWG (electromagnetic compatibility) if the installation and operation instructions are followed.

Supplier:

	ELTEK VALERE INDUSTRIAL GmbH Schillerstraße 16 D-32052 Herford
	+ 49 (0) 5221 1708-210
FAX	+ 49 (0) 5221 1708-222
Email	Info.industrial@eltekvalere.com
Internet	http://www.eltekvalere-industrial.com

© Copyright ELTEK VALERE INDUSTRIAL 2008. All rights reserved.

AC Rack
ACR INV222-6.75 HV

User Manual
Page 3 (20)



The current revision status of this user manual:

Revision: 2.0

Date: 2008-12-08

Revision	Description of change	Writer	Date
00	First edition, based on the LV version, ...R02	RTH	2008-09-01
01	Connection table corrected	RTH	2008-09-26
1.2	Actual picture "Rear view" inserted, the new revision status numbering (X.X) introduced	RTH	2008-10-29
2.0	Pinning of X23 (connector alarm relay) corrected	RTH	2008-12-08

Table of Contents

1. SAFETY INSTRUCTIONS	6
2. WASTE DISPOSAL RULES.....	6
3. GENERAL INFORMATION	7
3.1 Block Diagram	7
3.2 Possible Configurations.....	8
3.3 Perspective View	9
3.4 Optional Equipment:.....	9
3.5 Cooling/Air Flow Direction	10
4. HANDLING	11
4.1 Storage	11
4.2 Commissioning.....	11
4.2.1 Assembling.....	11
4.2.2 Communication Interface	12
4.2.3 CAN-BUS Addresses	12
4.2.4 CAN-Bus Termination.....	12
4.2.5 Rear View/Electrical Connectors.....	13
4.2.6 Connection Tables.....	13
4.2.7 Schematic Diagram (Example of use).....	15
5. MAINTENANCE	16
6. TECHNICAL SPECIFICATIONS	17
6.1 Dimensional Drawings:.....	18
7. NOTES.....	19

Index of Figures

Figure 1) - Block diagram7

Figure 2) - AC rack fully equipped.....9

Figure 3) - Sub rack airflow 10

Figure 4) - Front view of the empty rack 11

Figure 5) - Rear view of the rack 12

Figure 6) - Detail: CAN-Bus termination switch..... 12

Figure 7) - Rear side connectors..... 13

Figure 8) - Schematic diagram (example of use) 15

Figure 9) - Rack dimensions 18

1. Safety Instructions



Warning!

Because several components of operating electrical devices are charged by dangerous voltage, the improper handling of electrical devices may be the cause of accidents involving electrocution, injury, or material damages.

- Operation and maintenance of electrical devices must be performed by qualified skilled personnel such as electricians in accordance with EN 50110-1 or IEC 60950.
- Install the module only in areas with limited access to unskilled personnel.
- Before starting work, the electrical device must be disconnected from mains. Make sure that the module is earthed.
- Do not touch connector pins as they can be charged with dangerous voltage up to 30 seconds after disconnection.
- Only spare parts approved by the manufacturer must be used.

2. Waste Disposal Rules

All electric devices must be disposed of separate from domestic waste at collecting points that have been set up by the government or municipal authority.

“Separate collection is the precondition to ensure specific treatment and recycling of WEEE and is necessary to achieve the chosen level of protection of human health and the environment in the Community.”

The above statement from EU directive 2002/96/EC applies to all electric devices installed within EU countries.

In countries outside the EU, different rules may apply regarding waste disposal of electric devices.

For more information about waste disposal of your discarded equipment, contact your ELTEK VALERE INDUSTRIAL partner.

3. General Information

The AC rack is a unit ready for integration in system cabinets with a standard 19" frame. It is designed as a stand-alone rack (not cascable). The unit can be equipped with a maximum of three inverters of type INV222 plus one static transfer switch STS207 and delivers an output power to a maximum of 6.75kVA. After safe mechanical and electrical connection, the unit is ready for operation.

3.1 Block Diagram

ACR INV222-6.75 HV

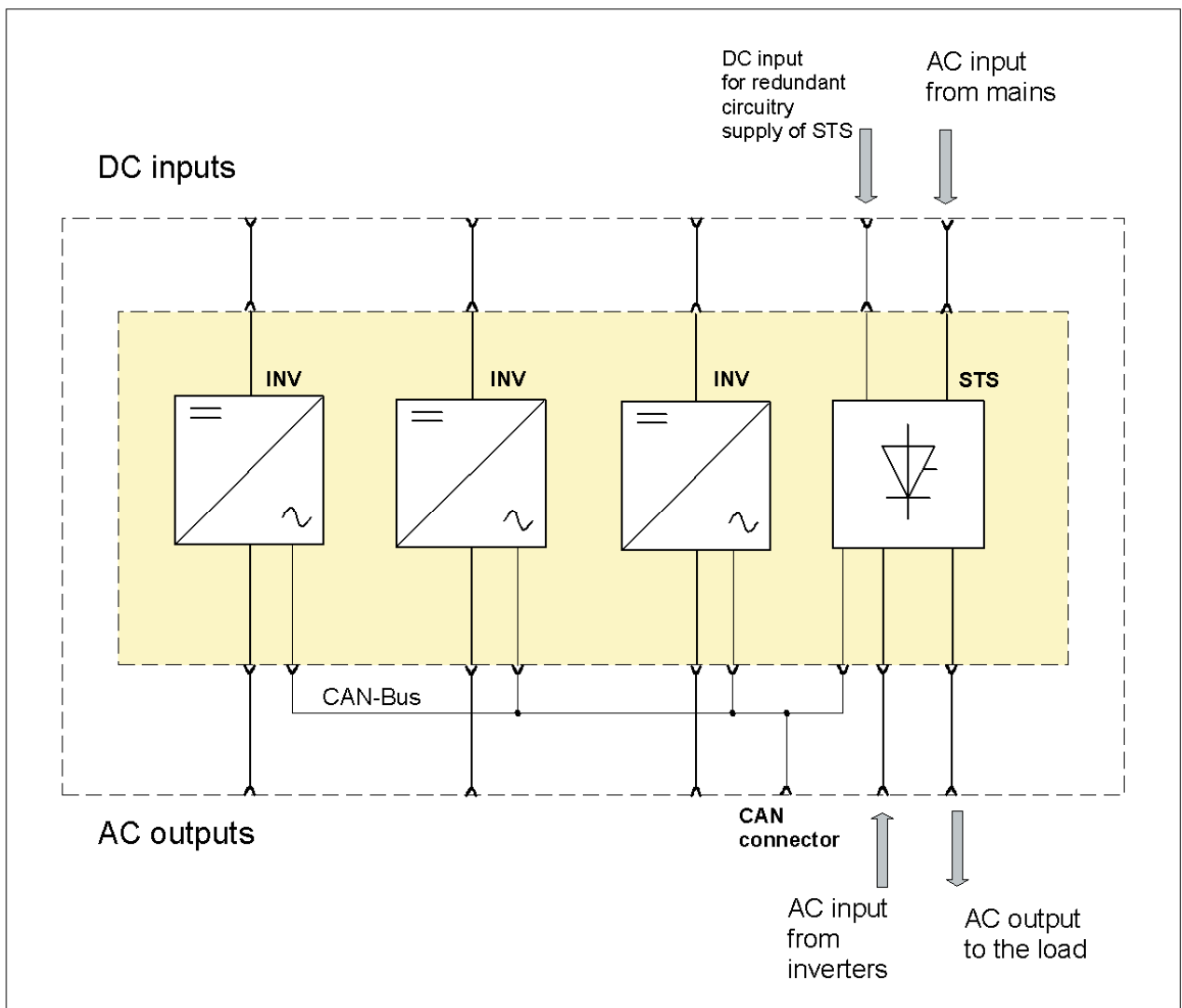

Figure 1) - Block diagram

AC Rack

ACR INV222-6.75 HV

User Manual
Page 8 (20)

3.2 Possible Configurations

Up to three INV222 with DC input voltages according to the table below plus one static transfer switch STS207 (obligatory) can be integrated into one rack.

Rack designation	Material code		For inverter/ input voltage	Necessary type of static transfer switch STS207/material code
ACR INV222-6.75 HV	502-222-315.HV	Output voltage= 230V _{AC}	INV222/110 V _{DC}	STS207-HV/601-070- 715.00
			INV222/220V _{DC}	

Output power of the rack, equipped with INV222:

Number of installed inverters (INV222)	Output power (without redundancy)	Output power (n + 1)	Output power (n + 2)
1	2250VA	---	---
2	4500VA	2250VA	---
3	6750VA	4500VA	2250VA

3.3 Perspective View

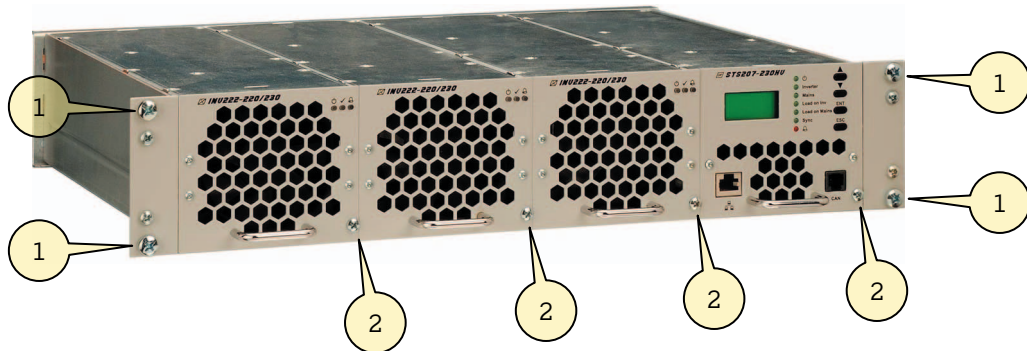

Figure 2) - AC rack fully equipped with three inverters INV222 and one static transfer switch STS207.

1	Four screws M6 to fix the sub rack to the frame of the system cabinet	Component parts of the sub rack
2	One captive screw per module is used to fix it to the sub rack	Component part of the module

3.4 Optional Equipment:

Optional equipment according to the following table is available:

Description	Material Code
Cover plate (with handle), necessary to cover empty slots, 1/4 x 19", 2U, colour RAL 7035	881-MEC-BPL.02.21.B

3.5 Cooling/Air Flow Direction

The INV222 and STS207 units are cooled with internal fans. The airflow is from the front to rear side. The fans are monitored and speed controlled dependent on module temperature. To provide sufficient air flow, a minimum space (see item "A" in figure 3) of 50 mm is required between the backplane of the rack and the rear cabinet wall as well as an unobstructed supply of air to the front of the modules.

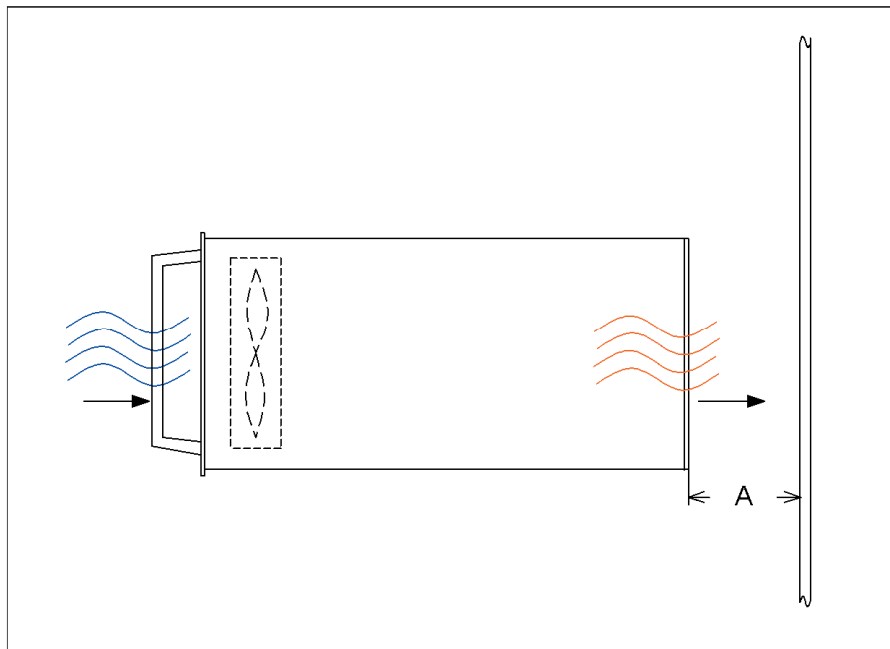

Figure 3) - Sub rack airflow

4. Handling

4.1 Storage

AC racks must be stored in a dry, dust free environment with a storage temperature in accordance with the specific technical data (see section 6).

4.2 Commissioning

- Carefully unpack the unit and integrate it in your power supply cabinet with 4 screws M6 (1) at the front side.

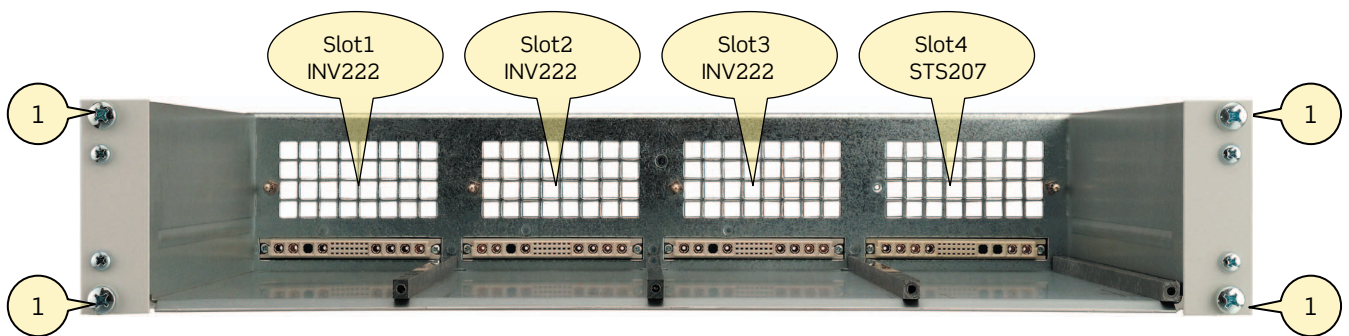

Figure 4) - Front view of the empty rack

4.2.1 Assembling

- Assemble the modules into the slots of the sub rack.
- Fill the rack beginning with the left slot (slot 1 to 3 for INV222, slot 4 for STS207)
- Fix the modules with the captive screws.
- Not used slots must be covered with cover plates (see section “Optional Equipment”).

4.2.2 Communication Interface

The AC rack is equipped with a serial data interface in accordance with the Controller Area Network (CAN) specification.

Several racks and/or modules in a system can be controlled and monitored through the CAN-Bus by a central DC controller unit UPC3.

Two CAN-Bus connectors (X21= CAN 1; X22= CAN 2) are located at the rear of the sub rack (see figure 5).

4.2.3 CAN-BUS Addresses

All modules within a system must have a specific CAN-BUS address for a clear identification through the central controller unit.

The CAN-BUS addresses of the installed inverters are automatically designated by the AC rack.

4.2.4 CAN-Bus Termination

The CAN-Bus must be terminated at both ends. If no other power rack and/or module is connected (CAN 2 not used), the CAN termination resistor must be enabled by setting the CAN termination switch 1, 2 or both (shown in figure 6) to “ON” position.

If CAN 2 is connected too, the CAN termination resistor must be disabled by setting the CAN-Bus termination switches 1 **and** 2 to “OFF” position. For switch functions in detail, see the table below.

Table “CAN-Bus termination switch functions”

Switch 1 position	Switch 2 position	CAN-Bus termination resistor:
ON	OFF	Enabled
OFF	ON	Enabled
ON	ON	Enabled
OFF	OFF	Disabled

ATTENTION: Missing terminations or too many terminations within the system can disturb the CAN-Bus communication. No more than two termination resistors should be activated on one bus and these should be located at both ends of the bus.

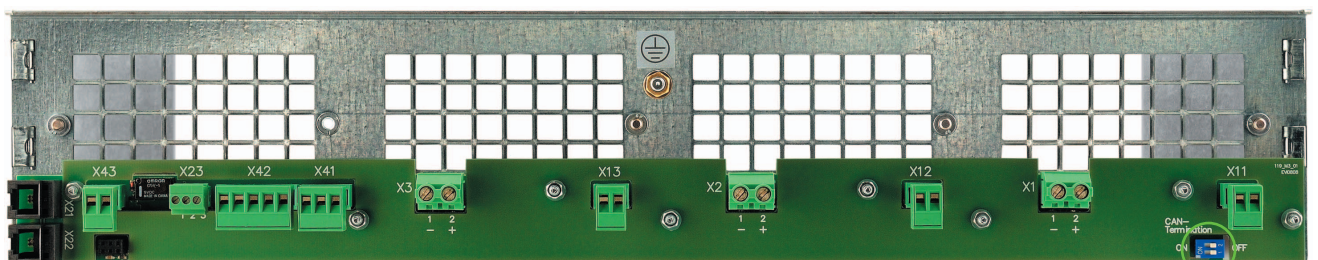

Figure 5) - Rear view of the rack

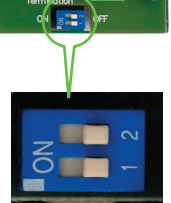

Figure 6) - Detail: CAN-Bus termination switch

4.2.5 Rear View/Electrical Connectors

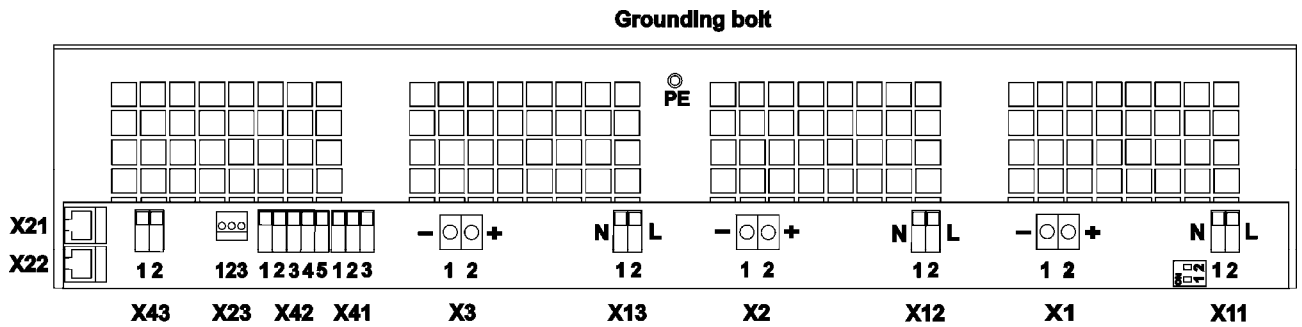

Figure 7) - Rear side connectors

Connect the terminals according to the connection tables on the following pages.

REMARK: The rack itself must be grounded with the cabinet frame (common PE of the system) on the special grounding bolt (PE).

4.2.6 Connection Tables

Assignment of the rear side connectors according to figure 7).

Connector	Function	DC input voltage of the inverters			
		110V _{dc}		220V _{dc}	
		Recommended external fuses	Recommended wire cross section	Recommended external fuses	Recommended wire cross section
X1.1	(-) DC input Inverter 1	25A	4mm ²	16A	2.5mm ²
X1.2	(+) DC input INV 1				
X2.1	(-) DC input INV 2	25A	4mm ²	16A	2.5mm ²
X2.2	(+) DC input INV 2				
X3.1	(-) DC input INV 3	25A	4mm ²	16A	2.5mm ²
X3.2	(+) DC input INV 3				

AC Rack

ACR INV222-6.75 HV

User Manual
Page 14 (20)

Connector	Function	Recommended external fuses	Recommended wire cross section
X11	AC output of inverter 1		
1	Neutral		1.5 mm ²
2	Line output	10A	1.5 mm ²
X12	AC output of inverter 2		
1	Neutral		1.5 mm ²
2	Line output	10A	1.5 mm ²
X13	AC output of inverter 3		
1	Neutral		1.5 mm ²
2	Line output	10A	1.5 mm ²
X41	AC line input to STS (coming from inverters)		
1	Line from inverter	No	3 x 1.5 mm ² (All three lines must be connected)
2	Line from inverter		
3	Line from inverter		
X42			
1	Neutral connection to STS (only measuring)	No	1.5 mm ²
2	AC line input to STS (coming from mains)	32A (@230VAC)	2 x 2.5 mm ² (both lines must be connected)
3	AC line input to STS (coming from mains)		
4	Line output of the STS (to the load)	32A (@230VAC)	2 x 2.5 mm ² (both lines must be connected)
5	Line output of the STS (to the load)		
X43	DC input to STS (redundant circuitry supply)		
1	minus	MCB C2	0.75mm ²
2	plus		
X23	Common Alarm Relay output of STS		
1	NO (normally opened) contact	No	0.5mm ²
2	COM (common) contact	No	0.5mm ²
3	NC (normally closed) contact	No	0.5mm ²

X21	CAN 1 (RJ11, 6-pole)	Cord Set
X22	CAN 2 (RJ11, 6-pole)	Cord Set

4.2.7 Schematic Diagram (Example of use)

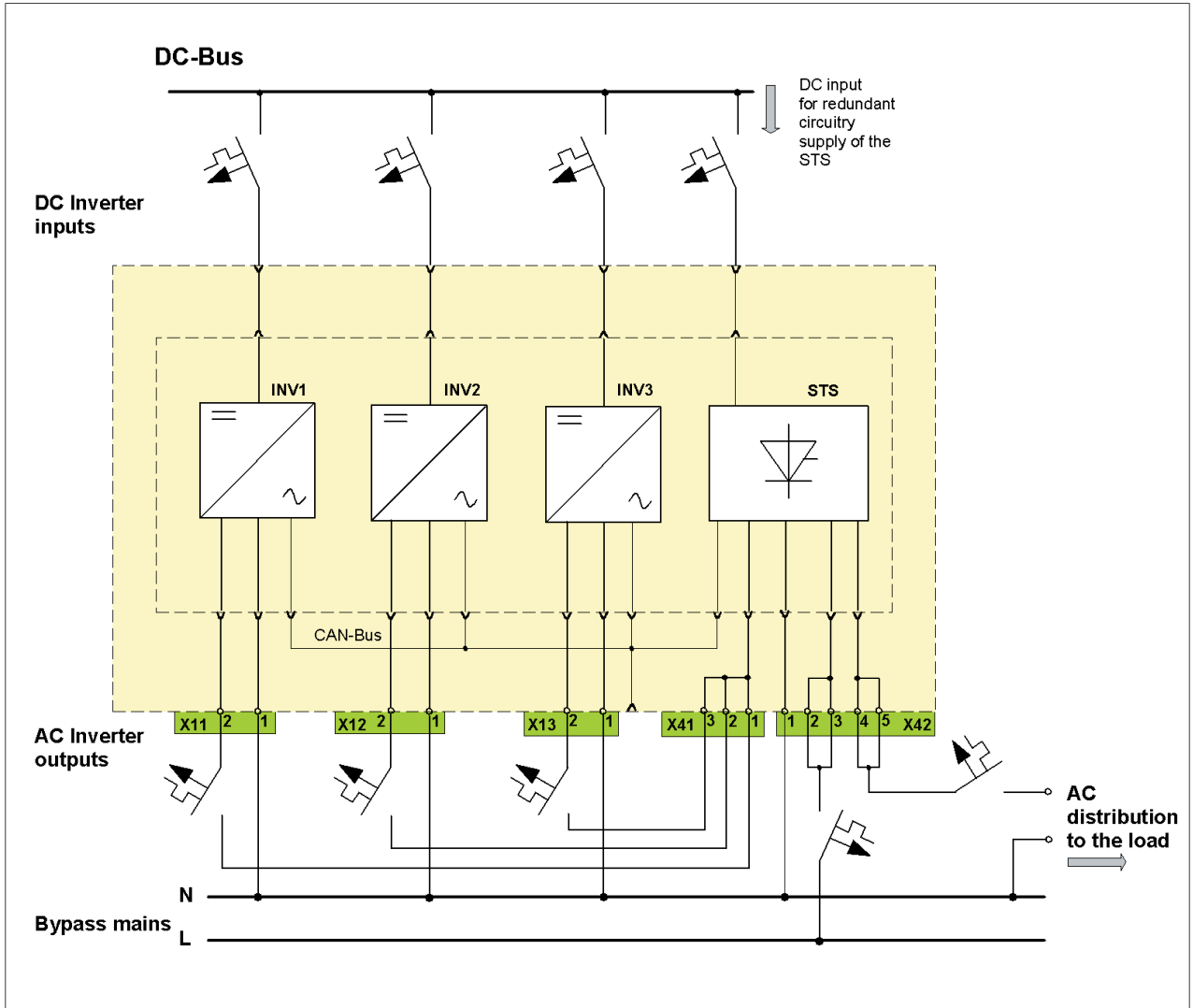

Figure 8) - Schematic diagram (example of use)



We recommend an individual fuse for each input!
 With this fuse you can switch ON/OFF each module individually.

Recommended input fuses and output fuses: See the tables on previous pages.

5. Maintenance

In general, the system is maintenance-free.
A yearly inspection with following checks is recommended:

- Correct fan operation (modules)
- Mechanical inspection
- Removal of dust and dirt
- Check for internal dust or humidity

Attention! Dust combined with moisture or water may influence or destroy the internal electronic circuits.

Dust inside the unit can be blown out with dry compressed air.
The interval between the checks depends on the ambient conditions of the installed system.

To exchange defective fans in the inverter modules, an additional instruction manual is available on request.

6. Technical Specifications

Type designation	ACR INV222-6.75 HV
Material code	502-222-315.HV
Main Data:	
Modules	Designed for the use of one up to a maximum of three DC/AC inverters of series INV222 ($V_i = 110; 220V_{DC}$) and one static transfer switch STS207 (HV version)
Input voltage	110; 220V _{DC} , depending on the used inverters
Internal input fuses	There are no internal fuses, we recommend an individual fuse for each input.
Output voltage	230V _{AC}
Output power	INV222: 2.25 up to 6.75kVA @ $\cos \phi = 0,8$
Electric connectors:	
DC input	3 x input (1 for each module), screw terminal
DC input for STS207 (redundant DC supply)	screw terminals
AC mains bypass input to STS	230V _{AC} , 50/60Hz, screw terminals
AC line input to STS (from inverters)	230V _{AC} , 50/60Hz, screw terminals
AC outputs of inverters	3 x (screw terminals)
AC output of STS (to the load)	230V _{AC} , 50/60Hz, screw terminals
Signalling contacts	1 x potential free relay output COM, NO, NC; (STS207 common alarm)
Communication interfaces	2 x isolated CAN-Bus connectors (RJ11, 6-pole)
Environmental:	
Max. installation altitude	≤1500 m
Ambient temperature	operation: -20°C...+55°C; storage: -40°C...+85°C
Audible noise	≤ 45dB(A) at 1m distance

Mechanical:

Type of construction	Sub rack, 19", 2U
Cooling	The modules are fan-cooled (front-to-rear airflow), temperature-regulated and monitored
Surfaces	powder coating RAL 7035 (front only), constructive parts: anodized metal
W/H/D	483/88.5/350mm (19", 2U)
Minimum installation depth	400mm
Weight	approx. 4.9 kg (excluding INV and STS modules)

Applicable standards:

Mechanical construction	acc. to VDE 0160 edition 5.88 chapter 7.2.2
Protection class	IP20
Climatic conditions	acc. to IEC 721-3-3 class 3K3/3Z1/3B1/3C2/3S2/3M2
RFI suppression/immunity	CE-label, (EN50081-1, EN55011/55022 class „B“, EN50082-2, EN61000-4 part 2/3/4/5)
Compliance to safety standards	acc. to EN60950-1, VDE0100 T410, VDE0110, EN60146

6.1 Dimensional Drawings:

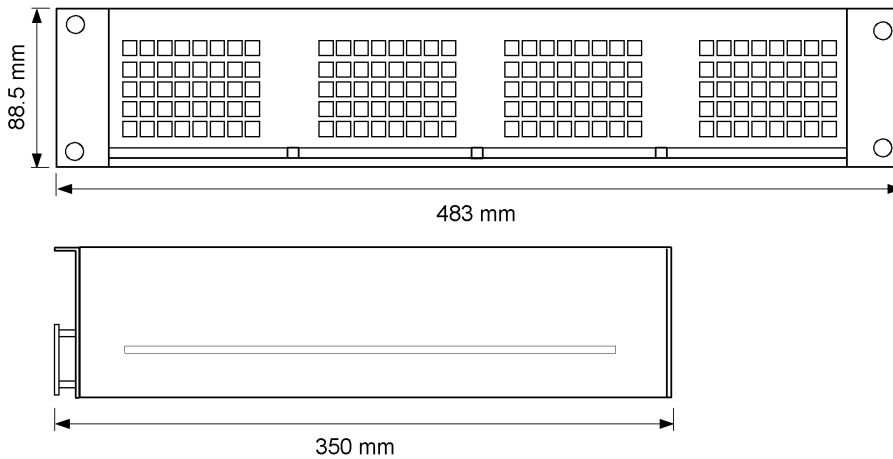

Figure 9) - Rack dimensions

7. Notes



Supplier:

	ELTEK VALERE INDUSTRIAL GmbH Schillerstraße 16 D-32052 Herford
	+ 49 (0) 5221 1708-210
FAX	+ 49 (0) 5221 1708-222
Email	Info.industrial@eltekvalere.com
Internet	http://www.eltekvalere-industrial.com