

DC/AC INVERTER

INV222

USER MANUAL



Notes to this manual

ATTENTION! Read this manual very carefully before installing and commissioning the specified module. This manual is a part of the delivered module. Familiarity with the contents of this manual is required for installing and operating the specified module. The rules for prevention of accidents for the specific country and the general safety rules in accordance with IEC 364 must be observed.

The function description in this manual corresponds to the date of publishing. Technical changes and changes in form and content can be made at any time by the manufacturer without notice. There are no obligations to update the manual continually.

The module is manufactured in accordance with applicable DIN and VDE standards such as VDE 0106 (part 100) and VDE 0100 (part 410). The CE marking on the module confirms compliance with EU standards 2006-95-EG (low voltage) and 2004/108/EG (electromagnetic compatibility) if the installation and operation instructions are followed.

Supplier:

	ELTEK VALERE DEUTSCHLAND GmbH GB Industrial Schillerstraße 16 D-32052 Herford
	+ 49 (0) 5221 1708-210
FAX	+ 49 (0) 5221 1708-222
Email	Info.industrial@eltekvalere.com
Internet	http://www.eltekvalere.com

©2009. ELTEK VALERE DEUTSCHLAND GmbH. All rights reserved.

DC/AC Inverter INV222

User Manual
Page 3 (20)

The current revision status of this user manual:

Revision: 4.0

Date: 2009-06-25

Revision	Description of change	Writer	Date
00	First edition	RTH	2007-10-24
01	Section "Commissioning" reworked, minor text modifications	RTH	2008-03-17
02	Section "Trouble shooting" reworked	RTH	2008-04-08
03	Index of Figures inserted	RTH	2008-04-15
04	Figure 1 & 2: Minor modifications	RTH	2008-04-23
1.0	Tables "LED indications" and "Monitoring" completed, section "Technical Data" modified, new revision status numbering (X.X) introduced.	RTH	2009-01-15
2.0	Input voltage value of the 60V version updated.	RTH	2009-02-05
3.0	View of the rear side connector corrected.	RTH	2009-04-08
4.0	Section 8) „External input fuses“ reworked	RTH	2009-06-25

TABLE OF CONTENTS

1. SAFETY INSTRUCTIONS.....	5
2. WASTE DISPOSAL RULES	5
3. GENERAL INFORMATION.....	6
3.1 TYPICAL APPLICATIONS.....	6
4. TYPE RANGE/MAIN DATA.....	7
4.1 MAIN OUTPUT DATA.....	7
4.2 AVAILABLE OPTIONS AND ASSEMBLY EQUIPMENT	8
4.3 FRONT VIEW/FRONT LED PANEL.....	9
4.4 REAR SIDE CONNECTION	10
4.5 COOLING AND AIR FLOW DIRECTION.....	11
4.6 COMMUNICATION INTERFACE.....	11
5. HANDLING.....	12
5.1 STORAGE	12
5.2 COMMISSIONING	12
5.3 LED INDICATIONS.....	12
5.4 MONITORING	13
6. MAINTENANCE	13
7. TROUBLE SHOOTING.....	14
8. TECHNICAL SPECIFICATIONS.....	15
8.1 DIMENSIONAL DRAWINGS	17
NOTES.....	18

Index of Figures

<i>Figure 1. Inverter in parallel operation without STS.....</i>	<i>6</i>
<i>Figure 2. Inverter in parallel operation with STS.....</i>	<i>6</i>
<i>Figure 3. AC Rack ACR INV222-6.75.....</i>	<i>8</i>
<i>Figure 4. AC Rack ACR INV222-9.0.....</i>	<i>8</i>
<i>Figure 5. Front view</i>	<i>9</i>
<i>Figure 6. Male connectors.....</i>	<i>10</i>
<i>Figure 7. Air flow direction</i>	<i>11</i>
<i>Figure 8. Module dimensions</i>	<i>17</i>

1. Safety Instructions



WARNING!

Because several components of operating electrical modules are charged by dangerous voltage, the improper handling of electrical modules may be the cause of accidents involving electrocution, injury, or material damages.

- Operation and maintenance of electrical modules must be performed by qualified skilled personnel such as electricians in accordance with EN 50110-1 or IEC 60950-1.
- Install the module only in areas with limited access to unskilled personnel.
- Before starting work, the electrical module must be disconnected from mains. Make sure that the module is earthed.
- Do not touch connector pins as they can be charged with dangerous voltage up to 30 seconds after disconnection.
- Only spare parts approved by the manufacturer must be used.

2. Waste Disposal Rules

All electric modules must be disposed of separate from domestic waste at collecting points that have been set up by the government or municipal authority.

“Separate collection is the precondition to ensure specific treatment and recycling of WEEE and is necessary to achieve the chosen level of protection of human health and the environment in the Community.”

The above statement from EU directive 2002/96/EC applies to all electric modules installed within EU countries.

In countries outside the EU, different rules may apply regarding waste disposal of electric modules.

For more information about waste disposal of your discarded equipment, contact your ELTEK VALERE DEUTSCHLAND partner.

3. General Information

The inverter INV222 converts input side DC voltage to a stable sine wave output voltage.

The INV222 is a module with rear side connectors and is designed to be mounted in an assembly set sub rack (see section 4.2).

The inverter is controlled and monitored by internal microprocessors. Due to its state-of-the-art circuitry design, the unit has very low losses and therefore very compact dimensions, low weight and a very high power density.

To increase the reliability the inverter is designed to operate together with a static transfer switch of series STS207. The static transfer switch monitors the connected bypass mains and synchronizes the inverter output with mains frequency. In inverter priority mode the STS transfers the load supply to bypass mains in case of inverter faults, high overload or battery low voltage. The transfer is nearly without voltage interruption (< 4ms). The unit switches back to inverter operation automatically if the reason for the transfer is gone. In case of mains priority mode the inverter will take over the load if the mains voltage is not present, out of limits or heavy disturbed. The priority source is programmable on the STS unit (see separate manual).

The nominal output power per unit is 1.8kW/2.25kVA. Several modules can be switched in parallel to increase the system output power or to build redundant power supply systems (n + 1 principle).

3.1 Typical Applications

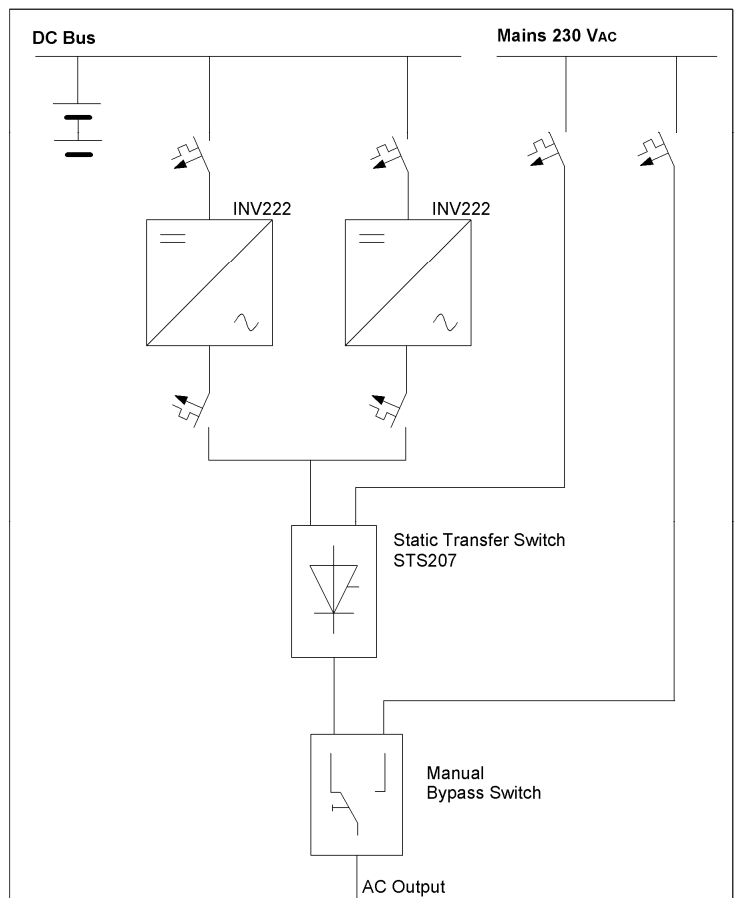
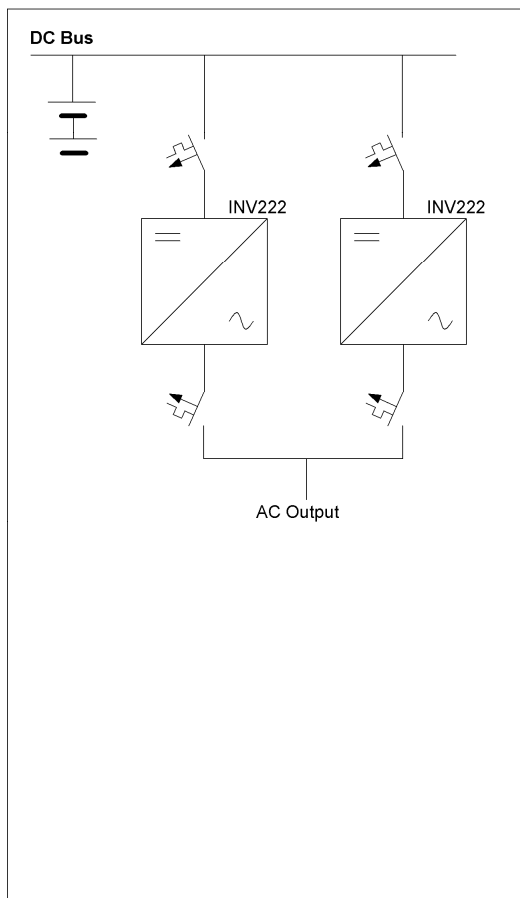

Figure 1. Inverter in parallel operation without STS Figure 2. Inverter in parallel operation with STS

4. Type Range/Main Data

Type Designation	Material Code	Nominal Input Voltage	Nominal Input Current	Input Voltage Range ($V_{MIN} - V_{MAX}$)
INV222-48/230-50	501-022-515.00	48V _{DC}	41.6A _{DC}	40.8- 67.5V _{DC}
INV222-60/230-50	501-022-615.00	60V _{DC}	33.3A _{DC}	52- 76V _{DC}
INV222-110/230-50	501-022-715.00	108V _{DC}	18.4A _{DC}	91.8- 135V _{DC}
INV222-220/230-50	501-022-815.00	216V _{DC}	9.2A _{DC}	183.6- 270V _{DC}

4.1 Main output data

Output Voltage: 230V_{AC}
Output Current: 9.8A_{AC} @ power factor 0.8; 7.8A_{AC} @ power factor 1.0 (resistive)
Output Frequency: 50/60Hz

For more specific data, [see section 8](#).

4.2 Available Options and Assembly Equipment

Designation	Material code
AC Rack ACR INV222-6.75 LV (assembly set 19" sub rack 2U including a wired backplane for max. three INV222-48 or INV222-60 and one static transfer switch STS207)	502-222-315.LV
AC Rack ACR INV222-6.75 HV (assembly set 19" sub rack 2U including a wired backplane for max. three INV222-110 or INV222-220 and one static transfer switch STS207)	502-222-315.HV
AC Rack ACR INV222-9.0 LV (assembly set 19" sub rack 2U including a wired backplane for max. four INV222-48 or INV222-60)	502-222-405.LV
AC Rack ACR INV222-9.0 HV (assembly set 19" sub rack 2U including a wired backplane for max. four INV222-110 or INV222-220)	502-222-405.HV
Cover plate (with handle), necessary to cover empty slots, 2U, colour RAL 7035	881-MEC-BPL.02.21.B



Figure 3. AC Rack ACR INV222-6.75 fully equipped with three inverters INV222 and one static transfer switch STS207

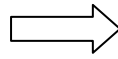

Figure 4. AC Rack ACR INV222-9.0 fully equipped with four inverters INV222

4.3 Front view/Front LED panel



Figure 5. Front view



The INV222 is fitted with the following three LED indicators:

- OPERATION
- OUTPUT OK
- ALARM

For more information about the LED indicators, see [section 5.3](#) and [section 7](#).

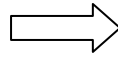

One captive screw is used for each module to secure it to the sub rack (component of the module).

4.4 Rear side connection

The rear side male connections (DC input voltage, AC output voltage and signals) are shown in figure 6.) and are defined in the following table:

Table: Pin assignment of the rear side male connector:

Pin	Designation
22b, 25b	DC input, plus pole
28b, 31b	DC input, minus pole
11b	PE
5b	AC output, Neutral
2b	AC output, Phase L1
15a	Alarm NC
16c	Alarm COM
19c	SYNC-STAT1 (synchronization bus 1, state lines)
20a	SYNC-SIG1 (synchronization bus 1, 50Hz-signal)
18c	SYNC-STAT2 (synchronization bus 2, state lines)
19a	SYNC-SIG2 (synchronization bus 2, 50Hz-signal)
20c	SYNC-GND (synchronization bus, ground)
14a	CAN-H
14c	CAN-L
13a	CAN-VSS
15c	CAN-VCC
17c	Address coding
16a	AGND

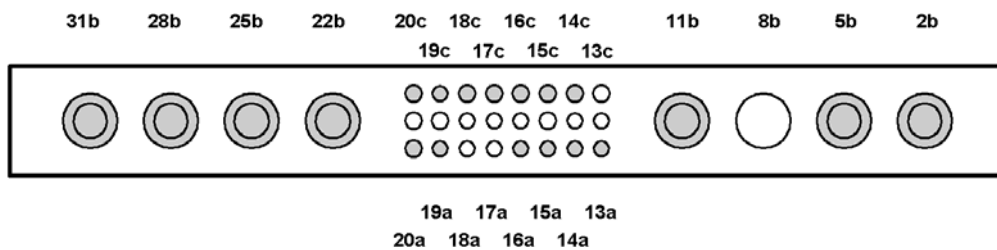

Figure 6. Male connectors (shown from the rear side of the module)

4.5 Cooling and Air Flow Direction

The unit is cooled with an internal fan. The airflow is from the front to rear side. The fan is monitored and speed-controlled dependent on module temperature. To provide sufficient air flow, a minimum space (see item "A" at figure 7.) of 50mm is required between the unit and the rear cabinet wall as well as an unobstructed supply of air.

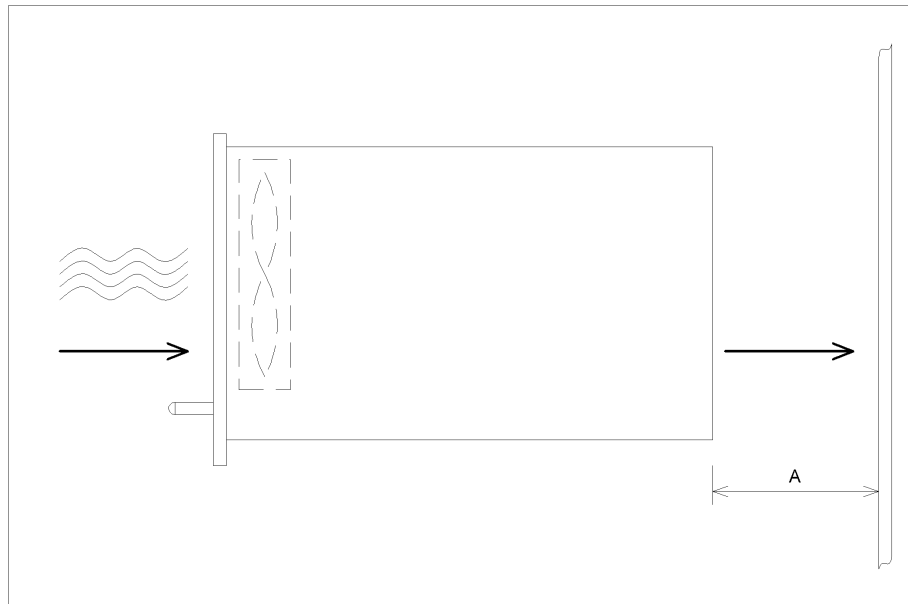

Figure 7. Air flow direction

4.6 Communication Interface

The inverter is equipped with a serial data interface in accordance with the Controller Area Network (CAN) specification. The CAN-Bus connection is integrated in the rear side connector.

Several inverters in a system or parallel connection can be controlled and monitored through the CAN-Bus by a central unit which is integrated in the static transfer switch unit STS.

The following parameters of a specific inverter unit can be controlled or monitored:

- Inverter status (OK/failure)
- Output voltage (measurement value)
- Output current (TRMS measurement value)
- Input voltage (measurement value)*
- Input current (measurement value)*
- Output frequency (measurement value)*
- Internal temperature (measurement value)*

*with separate software tool

5. Handling

5.1 Storage

The modules must be stored in a dry, dust free environment with a storage temperature in accordance with the specific technical data ([see section 8](#)).

5.2 Commissioning

Note: Before commissioning the module, make sure that the input voltage corresponds to the nominal input voltage of the unit as specified on the type plate.



1. Carefully unpack the unit
2. Fill the rack beginning with the left slot.
3. Put the unit into an empty slot.
4. Carefully slide in the unit until the module connector touched the backplane connector.
5. Increase the force until the unit fits in completely. Avoid using too much force. If the unit does not fit in, begin again at Step 3.
6. Secure the unit using the captive screw (M4x12) provided with the module.

Note: Before **removal** of a module it must be **switched off** by the external input fuse!

WARNING: After switching off the module the internal capacitors are still fully charged. Do not touch connector pins as they can still be charged with dangerous voltage after disconnection.

5.3 LED Indications

Functions of front panel LED indicators

LED	Colour	Function
	Green	OPERATION - Inverter operation; DC input voltage monitoring
	Green	OUTPUT OK - Output voltage monitoring
	Red	Collective Alarm* The following faults result in a collective alarm message: <ul style="list-style-type: none">• Input voltage high or low• Output voltage high or low• Short circuit or over load• Internal temperature higher than specified value• Fan failure

*The module is equipped with an isolated signalling contact (NC). The maximum load is 60V_{DC}/100mA.

For more information about the fault status and flashing patterns of the red LED see [section 7](#).

5.4 Monitoring

Monitoring functions

Monitored values	Criteria	Function
DC input voltage	Input voltage out of the range of factory set input voltage range V_{MIN}^* and V_{MAX}^*	1.) At V_{MIN} : Module automatically switches off and on with delay and hysteresis. 2.) At V_{MAX} : Immediately switch off.
AC output voltage	Output voltage out of the specified range of $V_{o<}$ and $V_{o>}$ $V_{o<} = 190V$ $V_{o>} = 253V$	1.) At $V_{o<}$: Simply a warning signal is generated 2.) At $V_{o>}$: Module automatically switches off. The module must be manually restarted.
Short circuit	$I_o > 130\% I_{nom}$ (9.8A)	Module automatically switches off after three seconds. The module automatically tries three times to restart. If this fails, the module switches off and must be manually restarted.
Overload	$I_o > I_{nom}$ (9.8A) $P_o > P_{nom}$ (1800W/2250VA)	Module automatically switches off after 10 seconds. The module must be manually restarted.
Temperature	Internal temperature higher than specified value*	Automatically switch-off at high over temperature and switch-on with hysteresis
Fan speed	$N < 500\text{min}^{-1}$	Automatically switch-off

* see specific technical data section ([section 8](#))

6. Maintenance

In general, the module is maintenance free.

A yearly inspection with following checks is recommended:

- Mechanical inspection
- Removal of dust and dirt, especially on radiator surfaces
- Check for internal dust or humidity

WARNING! Dust combined with moisture or water may influence or destroy the internal electronic circuits.

Dust inside the unit can be blown out with dry compressed air.

The interval between the checks depends on ambient conditions of the installed module.

7. Trouble Shooting















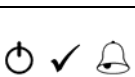





The following table shows all possible combinations of LED signals on the inverter unit.

The LED symbols mean:

Grey = LED off

Green or red = LED permanently on

Green or red with rays = LED is flashing

LED signal	Possible reason	Corrective action										
	1. No DC input voltage 2. Internal fault on circuitry	1. - Check input DC voltage - Check incoming distribution fuses - Check mounting position of the module 2. Exchange the unit										
	Inverter was remotely switched off via CAN-Bus	Check the STS controller for the reason of the switch-off command										
	DC input voltage low or high	Check DC input voltage level										
	Normal operation mode											
	Device switched off due to error	1. Restart the unit by switching on the input DC fuse 2. If the fault remains, exchange the unit										
	Output voltage low	Internal fault in circuitry; exchange the unit										
	Active Error Warning The following four errors are indicated: 1. Overload or short circuit 2. Fan fault 3. Over temperature 4. Output voltage high The module automatically switches off with time delay. Active errors are indicated with the following flashing patterns of the red LED:											
	<table border="0"> <tr> <td><u>Active error</u></td> <td><u>Flashing pattern</u></td> </tr> <tr> <td>1. Overload or short circuit</td> <td></td> </tr> <tr> <td>2. Fan fault</td> <td></td> </tr> <tr> <td>3. Over temperature</td> <td></td> </tr> <tr> <td>4. Output voltage high</td> <td></td> </tr> </table>	<u>Active error</u>	<u>Flashing pattern</u>	1. Overload or short circuit		2. Fan fault		3. Over temperature		4. Output voltage high		1. Reduce the load to nominal value (see section 7) or check the load circuitry for short circuit 2. Exchange the unit or the internal fan (service personnel only) 3. Check all air ventilations; remove dirt and dust; check the environment temperature (see the values at section 8) 4. Internal fault in circuitry; exchange the unit
<u>Active error</u>	<u>Flashing pattern</u>											
1. Overload or short circuit												
2. Fan fault												
3. Over temperature												
4. Output voltage high												

If the module still does not work even though all checks have been done, contact your sales agent or the ELTEK VALERE DEUTSCHLAND service department.

8. Technical Specifications

Type designation:	INV222- 48/230-50	60/230-50	110/230-50	220/230-50
Article code	501-022-515.00	501-022-615.00	501-022-715.00	501-022-815.00
DC input:				
Nominal input voltage	48VDC	60VDC	108VDC	216VDC
Input voltage range (V_{MIN} - V_{MAX})	40.8-67.5VDC	52-76VDC	91.8-135VDC	183.6-270VDC
Reflected input voltage ripple, psophometric (CCITT-A-filter)	$\leq 1.8\text{mV}$	$\leq 1.8\text{mV}$	---	---
Nominal input current	41.6ADC	33.3ADC	18.4ADC	9.2ADC
Inrush current	\leq nominal input current			
Overall efficiency	$\geq 90\%$			
Internal input fuse	there is no internal input fuse			
Recommended external input fuse:	63A	63A	25A	16A
AC output:				
Nominal output voltage	230V _{AC} $\pm 0.5\%$, factory adjustment range: 200...242V _{AC} . Factory setting: Parallel mode: 230V _{AC} -5%			
Threshold value of the output voltage	$V_{O<} = 190\text{VAC}$; $V_{O>} = 253\text{VAC}$			
Nominal output current	9.8A _{AC} @ power factor= 0.8; 7.8A _{AC} @ power factor= 1.0 (resistive)			
Output frequency	50Hz $\pm 0.05\%$, adjustable to 60Hz at factory. Synchronization range by external static transfer switch unit 45-65Hz			
Nominal output power	1800W/2250VA @ power factor=0.8			
Output power factor range	0.5 ind. – 1 – 0.5 cap.			
Overload capability	130% for 3 sec; 110% for 10 sec.			
Total harmonic distortion	$< 2\%$ for linear load			
Crest factor	≤ 3			
Dynamic behaviour	$\leq 3\%$ for load transients between 10% - 100% -10% of nominal output current (transient time ≤ 0.3 ms)			
Short circuit protection	sustained short circuit proof, short circuit current 2-2,5x I _{nom} for approx. 3 sec (with delayed restart)			
Internal output fuse	there is no internal output fuse			
External output fuse	10A gL or MCB characteristic B			

Other specifications:

Monitoring	DC-input voltage, (V_{MIN} , V_{MAX}) with automatic switch ON/OFF function, AC-output voltage (warning at $V_{\text{O<}}$, switch off at $V_{\text{O>}}$), over temperature and overload with automatic switch off function
LED signalling	OPERATION (green), V_{O} OK (green), ALARM (red)
Electronic protection	input under voltage, input over voltage, over temperature, overload and short circuit protection
External synchronization	External synchronization over static transfer switch.
Parallel operation	Parallel operation without any additional equipment and without fixed master possible; max. eight modules, load sharing approx. 5% I_{nom} due to decreasing output line characteristic
Communication	CAN-BUS interface to communicate with a static transfer switch STS
Isolated signalling contacts	“Collective Alarm”, relay contact NC; maximum contact load: 60V/0.1A
Cooling	fan cooling (temperature regulated, monitored)
Max. installation altitude	≤ 1500 m
Ambient temperature	operation: $-20^{\circ}\text{C} \dots +55^{\circ}\text{C}$ (power derating 2%/K above $+40^{\circ}\text{C}$); storage: $-40^{\circ}\text{C} \dots +85^{\circ}\text{C}$
Audible noise	$\leq 45\text{dB(A)}$ at 1m distance
Surfaces	powder coating RAL 7035 (front panel only) with black imprint, constructive parts: anodized metal
W/H/D	106.4/88.4/335mm(1/4 x 19”, 2U)
Minimum installation depth	400mm (in combination with a specific assembly set 19” sub rack)
Weight	approx. 3.5 kg
Connectors	DC-Input , AC-Output and signals: DIN 41612-M-connector

Applicable standards:

Mechanical construction	acc. to VDE 0160 edition 5.88 chapter 7.2.2
Protection class	IP20
Climatic conditions	acc. to IEC 721-3-3 class 3K3/3Z1/3B1/3C2/3S2/3M2
RFI suppression / immunity	CE-label, (EN50081-1, EN55011/55022 class „B“, EN50082-2, EN61000-4 part 2/3/4/5)
Compliance to safety standards	acc. to EN60950-1, VDE0100 T410, VDE0110, EN60146

8.1 Dimensional Drawings

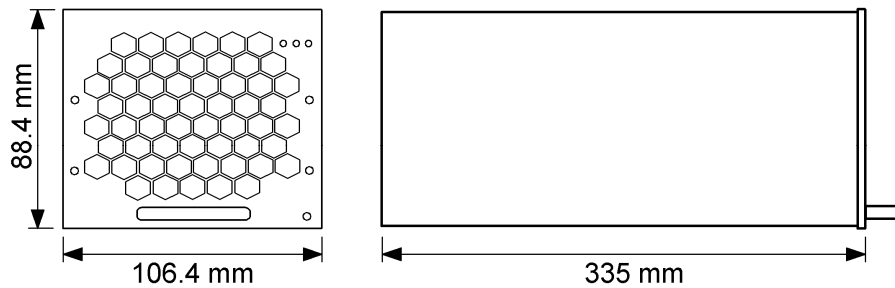

Figure 8. Module dimensions



Supplier:

	ELTEK VALERE DEUTSCHLAND GmbH GB Industrial Schillerstraße 16 D-32052 Herford
	+ 49 (0) 5221 1708-210
FAX	+ 49 (0) 5221 1708-222
Email	Info.industrial@eltekvalere.com
Internet	http://www.eltekvalere.com